

Systems Reference Library

IBM 1401 System Summary

This reference publication contains brief descriptions of the machine features, components, configurations, and special features. Also included is a section on programs and programming systems.

Publications providing detailed information on subjects discussed in this summary are listed in *IBM 1401 and 1460 Bibliography*, Form A24-1495.

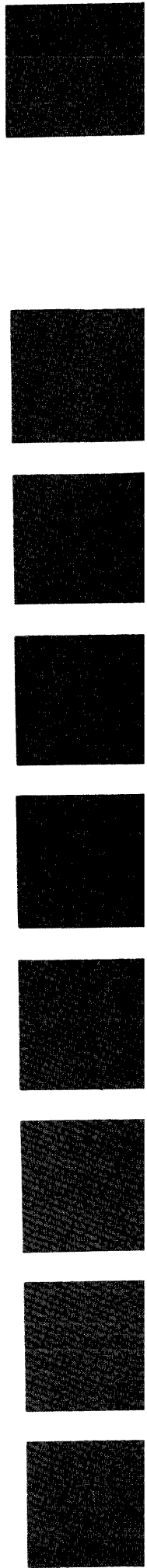

Major Revision (September 1964)

This publication, Form A24-1401-1, is a major revision of and obsoletes Form A24-1401-0. Significant changes have been made throughout the publication.

Reprinted April 1966

Copies of this and other IBM publications can be obtained through IBM Branch Offices.
Address comments concerning the content of this publication to IBM Product Publications, Endicott, New York 13764.

Contents

IBM 1401 System Summary	5
System Concepts	6
Card-Oriented System	11
Physical Features	11
Interleaving	14
Data Flow	14
Checking	15
Word Mark	15
Stored-Program Instructions	15
Operation Codes	18
Editing	18
IBM 1401 Console	19
IBM 1406 Storage Unit	20
Magnetic-Tape-Oriented System	22
Data Flow	22
Magnetic Tape	22
Disk-Storage-Oriented System	26
Data Flow	26
IBM 1311 Disk Storage	26
IBM 1405 Disk Storage	28
IBM 1407 Console Inquiry Station	29
Special Features	30
IBM 1401 Processing Unit	30
IBM 1402 Card Read-Punch	32
IBM 1403 and 1404 Printers	33
IBM 1405 Disk Storage	33
IBM 1311 Disk Storage Drive	33
Other Input/Output Units for the IBM 1401 System	35
IBM 1009 Data Transmission Unit	35
IBM 7710 Data Communication Unit	35
IBM 7740 Communication Control System	36
IBM 7770 Audio Response Unit	36
IBM 1026 Transmission Control Unit	36
IBM 1011 Paper Tape Reader	37
IBM 1012 Tape Punch	37
IBM 1231 Optical Mark Page Reader	37
IBM 1285 Optical Reader	38
IBM 1412 and 1419 Magnetic Character Readers	38
IBM 1418 Optical Character Reader	38
IBM 1428 Alphameric Optical Reader	39
IBM 1404 Printer	39
IBM 1445 Printer	40
IBM 7340 Hypertape Drive Model 2	40
IBM 1401 Programs and Programming Systems	42
Index	56

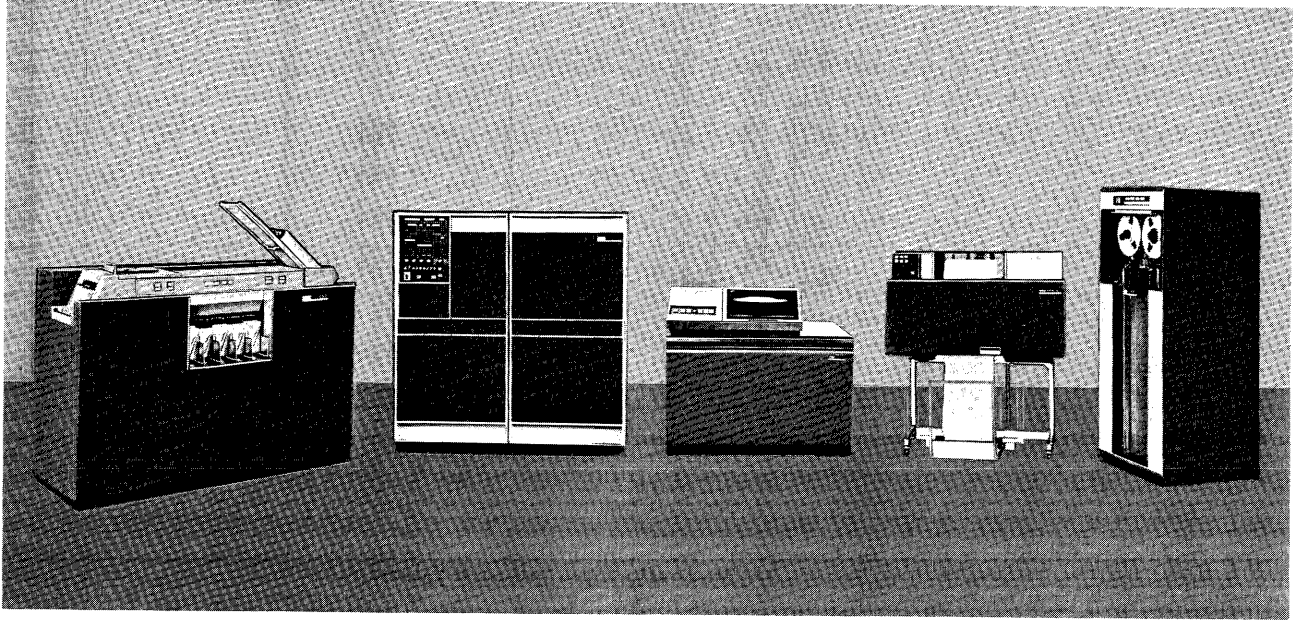

Figure 1. IBM 1401 Data Processing System

IBM 1401 System Summary

The IBM 1401 Data Processing System is designed to provide the transition from punched-card data processing *equipment* to the data processing *system* and to accommodate subsequent business growth through the various IBM 1401 system configurations. A data processing system consists of functional units to provide: data input, data processing, and data output.

The IBM 1401 system implements punched-card input and output, at speeds much faster than punched-card data processing equipment. This permits fast and economical data processing in areas where punched-card data processing is desirable but not fully efficient using punched-card data processing equipment.

Magnetic tape and magnetic disk can be used as sources of input data for processing and as devices for storage of output data. Each has its area of use, but both provide storage for large volumes of data for processing.

The IBM 1401 system can also accommodate input from and output to various other IBM units: Tele-processing or data communications units, magnetic-ink and optical-character-sensing units, and paper-tape units.

The IBM 1401 Processing Unit operates under control of a stored program. The processing unit receives input data from an input unit, processes the data, and provides output to an output unit. Machine instructions of the stored program direct the processing of data. The processing unit and the various input and output units can be equipped with special features to provide further advantages in system operation and programming.

IBM also provides programs and programming systems to relieve IBM 1401 users of much detailed programming effort. Among these are symbolic-language systems, report-program generating systems, disk file-organization programs, sorting and merging programs, utility programs, and input/output control systems.

System Concepts

The IBM 1401 can be considered in three major configurations: the card-, tape-, and disk-storage-oriented systems.

Card system configurations are planned for procedures involving large volumes of card documents as source data and output, with particular advantage to applications requiring re-entry data.

Tape system configurations accomplish data processing through the use of magnetic tape. This has the advantages of compact record handling and storage medium for high-speed data processing systems.

Disk-storage system configurations, through magnetic-disk storage, permit in-line data processing and increased storage capacity, in addition to all the advantages of a 1401 system.

The Stored Program

The main characteristic of data processing systems is self-controlled performance of procedures, carried to various degrees. Any such self-controlled performance simply includes a series of actions or movements, each depending on another and requiring no operator intervention in the completion of the series. The series can be very short, or very long. The series can be completely sequential, or the next action to be taken can be determined by the last action completed.

An automatic record player is a good example of a series of actions, each one depending on the one immediately preceding it. When records are loaded on the spindle and the record player is turned on, a record drops to the turntable; the playing arm positions itself at the starting position of the record; the record is played; the arm returns to a neutral position; the next record in sequence drops into place; the playing arm returns to the starting position on the new record; the record is played; and so on, until all the records have been played once, without any need for intervention or assistance by anyone. This series of actions is called a *program* (Figure 2).

In data processing systems, the program is more complex. It controls the entire flow of data in and out of various processing units. If, for instance, original data is punched into cards, the program controls the reading of this data, its transport to various processing areas for addition, subtraction, multiplication, division, modification, classification, recording, and any other kind of action to which data can be subjected.

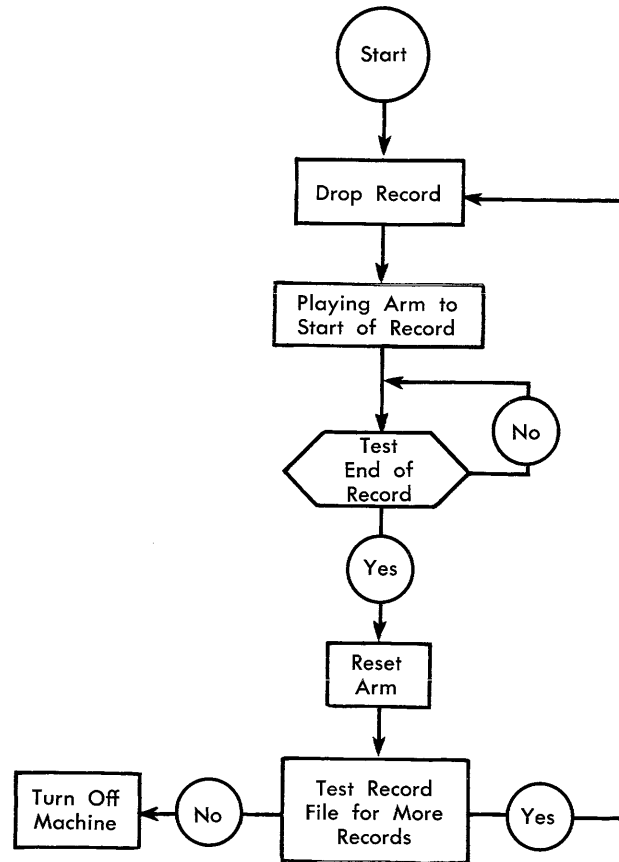

Figure 2. Block Diagram of a Program

A data processing system is a group of various interconnected mechanical and electronic components. A system of this kind must be able to handle and complete such a program. The concept of *stored programming* provides this flexibility and efficiency.

In punched-card data processing, the wires in the control panel actually comprise the program of instructions. The requirements of the procedure are studied carefully, and then the proper wires are placed in the control panel. The entire program can be changed by removing one control panel and replacing it with another for a different procedure. The factors limiting the extent to which punched-card data processing equipment can handle the program are the number of program steps that can be provided within the physical confines of the control panel, and the number of control panels that can be conveniently utilized.

Stored-program data processing systems use a similar, but much more flexible, concept. All the instruc-

tions needed to complete a procedure are written in the form of program steps. These program steps are made available to the machine by various methods, the most common of which is punched cards. The data processing system stores these program steps in a storage medium.

Thus, when a procedure is to begin, the program is *loaded* into the system (Figure 3), and the entire procedure can be performed from beginning to end. The IBM 1401 Data Processing System makes use of four kinds of storage: magnetic-core storage, magnetic-tape storage, magnetic-disk storage, and the already familiar punched-card storage.

Magnetic-Core Storage

All configurations of the IBM 1401 Data Processing System use magnetic-core storage for storing instructions and data.

The magnetic-core storage unit is composed of a number of tiny rings made of magnetic material. Several electric wires pass through each of these rings, and each ring is magnetized.

Every magnetic field has *polarity*. This can be demonstrated by the common phenomenon of two horse-shoe-shaped magnets, which attract each other firmly when turned one way, and repel each other just as strongly when turned the other way. Similarly, each magnetic core possesses a magnetic field. The polarity of this field is determined by whether a *bit* or a *no-bit* of information is stored. A core magnetized in one direction contains a bit of information. When the polarity is reversed, the core contains a no-bit of information. These two conditions are represented schematically by bit values of 1 (representing a bit) and 0 (representing a no-bit). All data in core storage is instantly available, and in the IBM 1401, the core-storage units have been specifically designed for high utility by making each

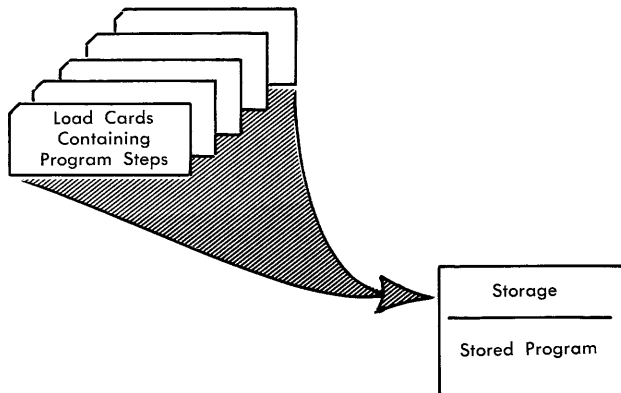

Figure 3. Stored Program

location of core storage *addressable*. Thus, a program step can designate the exact cores needed for that step.

Each location of core storage consists of a number of *planes* or levels of magnetic cores. Various combinations of bits designate digits, letters, and special characters (Figure 4). Notice that the planes are stacked, and the cores representing a single character (in this case the letter A) are all at the intersection of the same two wires in each plane.

The physical make-up of each core-storage location and its associated circuitry make it possible for the IBM 1401 to modify instructions and process data directly in the storage area. (This is called *add-to-storage* logic.)

The design, construction, and circuitry make the core-storage unit in the 1401 compact but extremely powerful.

Magnetic-Tape Storage

Magnetic tape is made of plastic material, coated with a metallic oxide. It has the property of being easily magnetized in tiny spots, so that patterns of these magnetized spots are codes for digits, alphabetic characters, and special characters.

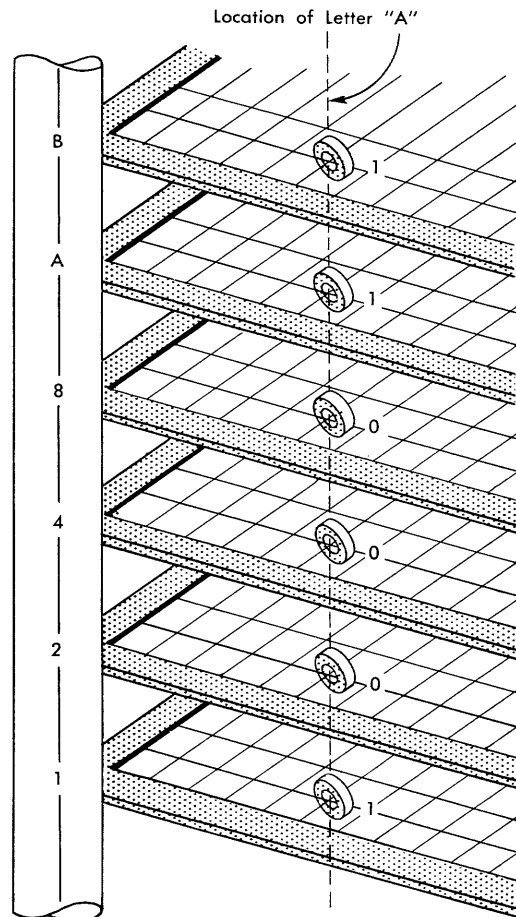

Figure 4. The Letter A Represented in Magnetic-Core Storage

Data can be read from a variety of sources and put on the tape. The magnetic spots representing the information stored on the tape remain until they are either erased or written over.

Because magnetic data can be kept permanently, magnetic tape is an ideal storage medium for a large volume of information. The reels of tape (Figure 5) are removable from the system, and can be filed. They can also be transported and used in other systems.

Data stored on the magnetic tape is read sequentially. The data processing system can search the tape to find the data to be used. Storing program steps on magnetic tape is a common method of collecting a *library* or file of programs.

Another great advantage of magnetic-tape storage is that a reel of tape produced as output of a procedure can be removed from the data processing system. With this tape, reports can be written with an independent unit, while the data processing system proceeds with the next program.

Magnetic-Disk Storage

Magnetic disks are thin metal disks that are coated on both sides with a ferrous oxide recording material. These disks are mounted on a vertical shaft, and are separated from one another. As the shaft revolves, it spins the disks at a constant speed.

Information is recorded on disks in the form of magnetized spots located in concentric tracks on each recording surface.

The magnetic disk can be used repeatedly. Each time new information is stored on a track, it erases the data formerly stored there. Records can be read from disks as often as desired until they are written over or erased.

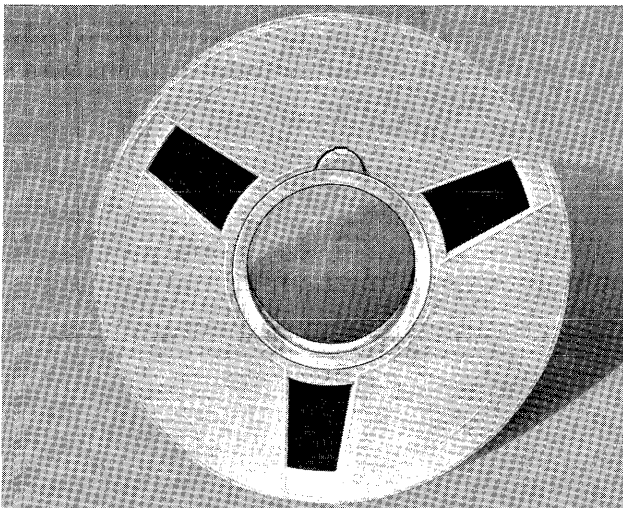

Figure 5. Reel of Magnetic Tape

In addition to providing increased storage capacity, magnetic-disk files permit processing data on a random basis. Because any record on any track is addressable, the IBM 1401 Processing Unit has access to any record in the disk-storage unit. This random accessibility is the key to the in-line approach to data processing. Transactions can be entered as they occur—regardless of sequence. The 1401 can process other data within core storage while the access mechanism searches for a record.

Language

In the punched-card area of data processing, the language of the machine is the holes in the card. As data processing needs increase, the basic card-language remains the hole in the card. But in the transition from punched-card data processing systems to data processing systems, another faster, more flexible machine-language emerges.

Just as each digit, letter, or special character is coded into the card as a punched hole or a combination of holes, it is coded into magnetic storage as patterns of magnetized spots.

Obviously, many different code patterns can be set up. The internal code used in the IBM 1401 Data Processing System is called *Binary Coded Decimal*. All data and instructions are translated into this code as they are stored. No matter how information is introduced into the system, the binary-coded-decimal representation is used in all data flow and processing from that point on, until it is translated into printed output when reports and documents are written or converted to card code for punching. Converting input data to the 1401 internal code, and subsequently reconvert, is completely automatic.

Processing

The manipulation that data undergoes in order to achieve desired results is called *processing*. The part of the 1401 system that houses these operations is called the *processing unit*.

Processing can be divided into three general categories: logic, arithmetic, and editing.

Logic

The logic function of any kind of data processing system is not only its ability to execute program steps, but also its ability to evaluate conditions and select alternative program steps on the basis of those conditions.

In punched-card data processing equipment, an example of this logic is selector-controlled operations based on an X or No-X, or based on a positive or negative value, or perhaps based on a comparison of control numbers in a given card field.

Similarly, the logic functions of the 1401 system make decisions and vary program operations based on comparisons, or positive or negative values.

Arithmetic

The 1401 processing unit has the capacity to perform add, subtract, multiply, and divide operations. Multiplication and division can be accomplished in any 1401 system by programmed subroutines. When the extent of the calculations might otherwise limit the operation, a direct multiply-divide feature is available.

Editing

As the term implies, *editing* adds significance to output data by punctuating and inserting special characters and symbols. The IBM 1401 has a unique ability to perform this function, automatically, with simple program instructions.

Checking

Advanced circuit design with extremely reliable components is built into the 1401 system to provide assurance of accurate results. Self-checking within the machine is separated into three categories: *parity*, *validity*, and *hole count*.

Solid-State Circuitry

Transistorized components (Figure 6) are another significant design characteristic of the IBM 1401. In addition to providing a lower cost system, the use of transistors increases reliability, while decreasing maintenance requirements. Other advantages are carefully controlled:

- space requirements
- heat dissipation
- power requirements.

The physical arrangement of the system components offers a less tangible, but equally important, benefit in greater operating efficiency, because the components requiring operator attention can be situated for accessibility and convenience. The controls and arithmetic components are consolidated into a single set of modular cabinets.

Thus far, only the most obvious advantages offered by the 1401 have been given. As the system components and features are described in greater detail, further advantages become evident. Power and economy of the 1401 are not derived from any single characteristic or component, but from the many considerations that led to the design of a balanced system in which every component can operate at its optimum rate.

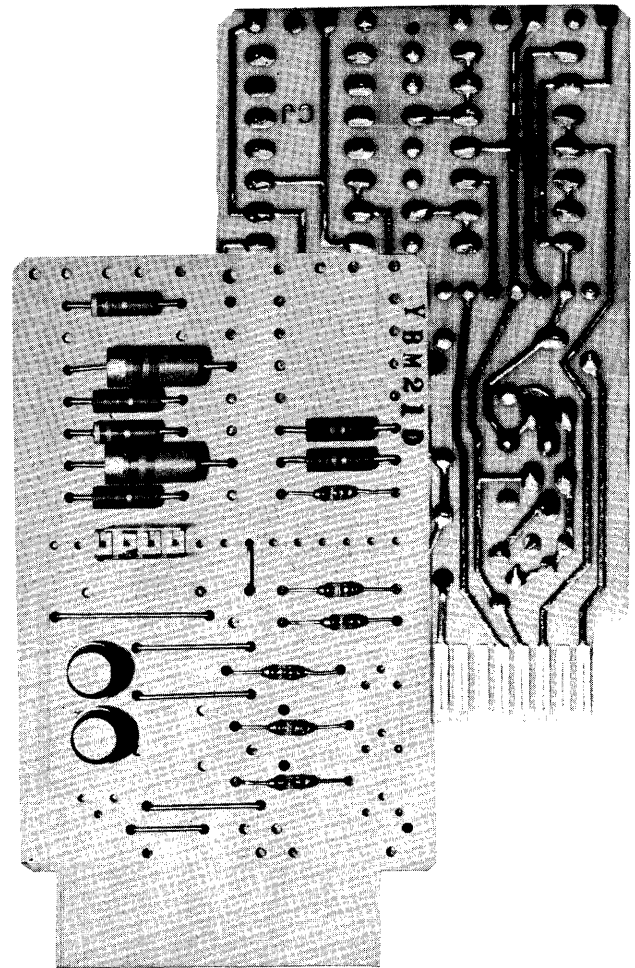

Figure 6. Transistor Cards

Advanced Design

Advanced systems design of the IBM 1401 permits using the machine as a complete, independent accounting system. It can also perform low-cost, direct input and output, and auxiliary tape operations for large-scale data processing systems.

The entire system is operated by the stored program. Timesaving features, such as the powerful editing function and the elimination of control panels, provide increased flexibility for application development. The capacity to use magnetic-tape data means economy in recording, transporting, and storing large volumes of information in compact form; and the availability of magnetic-disk storage permits in-line processing in addition to providing increased storage capacity.

IBM 1401 Used with Other IBM Systems

On-Line Operation

The IBM 1401 Data Processing System can be attached to either the IBM 7040 or the 7044 Data Processing Sys-

tem. This permits most of the components and features of the 1401 system to be used on-line with the larger system.

Off-Line Operation

The IBM 1401 has additional flexibility when it is used with tape-oriented configurations of large-scale, general-purpose IBM data processing systems. For example, the 1401 can produce, edit, sort, print, punch, and further manipulate tape data used by the IBM 7070 and 7080. This allows more time for the operations that are more efficient and practical for each system.

Program Assembly for Other Systems

IBM provides two 1401 programs that assemble users' source programs written for other IBM data processing

systems. One of these 1401 programs accepts IBM 1440 source programs as input, producing an assembled object program to be run on the IBM 1440. The other 1401 program accepts as input, source programs written for the IBM 7750 Programmed Transmission Control (a component of certain IBM Tele-processing systems). It produces as output IBM 7750 object programs. Thus, the IBM 1401 Data Processing System can assist users in programming IBM 1440 systems and certain IBM Tele-processing systems.

IBM Scientific Data Processing Systems

The column-binary feature enables the 1401 to process card and tape data recorded in binary form. This ability makes the 1401 especially useful as an auxiliary system for the IBM 704, IBM 709, and IBM 7090 Data Processing Systems.

The IBM 1401 card-oriented system is completely transistorized, and utilizes the modern technique of stored-program control. This system can perform all basic functions (such as: reading, printing, comparing, adding, subtracting, editing) and variations of these functions.

The IBM 1401 incorporates an advanced design of many outstanding features of existing equipment, for improved programming and operating efficiency:

1. Core storage provides instant access to information and the stored program. Every position can accommodate either an alphabetic or numeric character, and is individually addressable. Character time is .0115 millisecond.
2. Variable word length permits maximum utilization of the storage facility.
3. High-speed printing increases output efficiency.
4. High-speed reading and punching offer faster input and output and permit easy integration of the 1401 into existing accounting machine procedures.
5. Editing completes the preparation of information for printed output.

Physical Features

The physical features of the units that make up the card-oriented system are compact and of modern design. The units are mobile to permit an operating arrangement that is both convenient and efficient. The IBM 1401 Data Processing System in its card configuration is composed of three interrelated units:

1. IBM 1401 Processing Unit contains 1,400 positions of alphameric core storage (expandable to 2,000, 4,000, 8,000, 12,000, or 16,000 positions). The processing unit is the only unit that is changed in physical size when different system configurations are required.
2. IBM 1402 Card Read-Punch is equipped with either an 800-card-per-minute read feed and a 250-card-per-minute punch feed, or a 450-card-per-minute read feed and 250-card-per-minute punch feed (depending on the model).
3. IBM 1403 Printer is capable of printing as many as 600 or 465 lines per minute (depending on the model), with a print span of 100, 120, or 132 positions of alphabetic and numeric data per line, depending on the model.

IBM 1401 Processing Unit

The processing unit (Figure 7) contains the magnetic-core storage unit to store the program data and instructions and to perform all logic and arithmetic operations. Alphabetic and numeric characters are represented in storage by an 8-bit code. The eight bits consist of six bits for alphameric binary code, a seventh bit for checking, and an eighth bit for field definition.

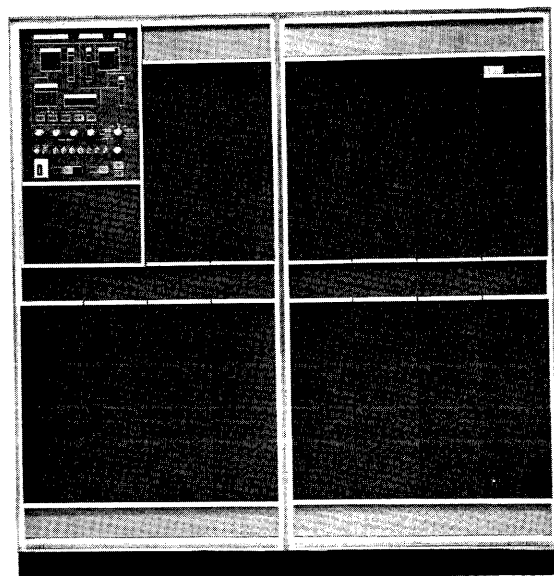
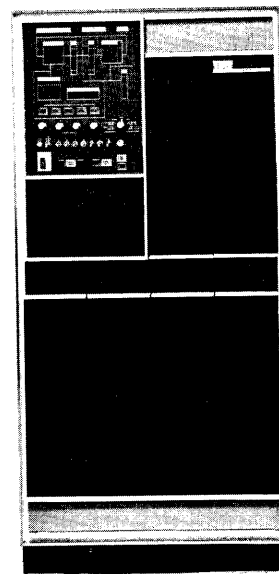

Figure 7. IBM 1401 Processing Unit (Two-Cube and Four-Cube)

Three areas of storage are reserved for input and output data. In the first, 80 storage positions receive 80 columns of card information from the card reader. Another 80 positions are reserved for assembly of data to be punched. The third area is reserved for the assembly of 100 (or 132) characters of printer information. However, when these areas are not being used as specified, they can be used for other purposes.

NOTE: If 132-character printing is ordered, the additional-print-control feature is required in the 1401.

Each of the storage positions is addressable and identified by a 3-character address. The first 1,000 positions of storage have the addresses 000-999. The remaining storage positions use an alphabetic or special character in the hundreds position of the address (Figure 8).

Stored programming involves the concept of *words*. A word is a single character, or group of characters, that represents a complete unit of information. One of the most important characteristics of the IBM 1401 Data Processing System is its use of the variable-word-length principle, in which words are not limited to any predetermined number of character positions in the storage unit. Each word occupies only that number of character positions actually needed for each specific instruction, or for the specific data involved. This facility contributes to the high efficiency of the 1401 core-storage unit.

IBM 1402 Card Read-Punch

The IBM 1402 Card Read-Punch (Figure 9) provides the card-oriented system with simultaneous punched-card input and output. This unit has two card feeds, one for reading and one for punching. The read section has a rated speed of either 800 cards per minute or 450 cards per minute, depending on the model. Actual card speed realized is governed by the program routine for each particular run. The read feed is equipped with a device for large-capacity loading, called a *file feed*. With the file-feed device, the read feed can be loaded with as many as 3,000 cards, which reduces operator-attendance requirements.

The 51-column read feed (special feature), interchangeable with the standard 80-column feed, allows the processing of stub cards, thus increasing the flexibility of the IBM 1401 Data Processing System.

The cards feed through the read side of the machine 9-edge first, face down. The feed path is from right to left, passing two sets of brushes (Figure 10). The *read check* station reads 80 columns of the card to establish a hole count for checking purposes. The *read* station also reads the 80 columns, proves the hole count, and directs the data into storage. At the end of the card-

CODED ADDRESSES IN STORAGE		
Actual Addresses		3-Character Addresses
000 to 999	No zone bits	000 to 999
1000 to 1099	A-bit, using 0-zone	#00 to #99
1100 to 1199		/00 to /99
1200 to 1299		S00 to S99
1300 to 1399		T00 to T99
1400 to 1499		U00 to U99
1500 to 1599		V00 to V99
1600 to 1699		W00 to W99
1700 to 1799		X00 to X99
1800 to 1899		Y00 to Y99
1900 to 1999		Z00 to Z99
2000 to 2099	B-bit, using 11-zone	0̄00 to 0̄99
2100 to 2199		J00 to J99
2200 to 2299		K00 to K99
2300 to 2399		L00 to L99
2400 to 2499		M00 to M99
2500 to 2599		N00 to N99
2600 to 2699		*O00 to O99
2700 to 2799		P00 to P99
2800 to 2899		Q00 to Q99
2900 to 2999		R00 to R99
3000 to 3099	A-B-bit, using 12-zone	+00 to +99
3100 to 3199		A00 to A99
3200 to 3299		B00 to B99
3300 to 3399		C00 to C99
3400 to 3499		D00 to D99
3500 to 3599		E00 to E99
3600 to 3699		F00 to F99
3700 to 3799		G00 to G99
3800 to 3899		H00 to H99
3900 to 3999		I00 to I99

* Letter O followed by Zero Zero

Figure 8. Storage Address Codes

transport path, three stackers are available to receive the cards. The *normal read* stacker is the stacker closest to the read hopper and is used unless the cards are program-directed to stackers 1 or 2.

The punch section has a rated speed of 250 cards per minute, with a card hopper capacity of 2,100 cards. The cards feed 12-edge first, face down. The feed path is left to right, passing a blank station, a punching station, and a reading station (Figure 10). The punching station consists of 80 punches for recording information. The punch-reading station counts all the holes in

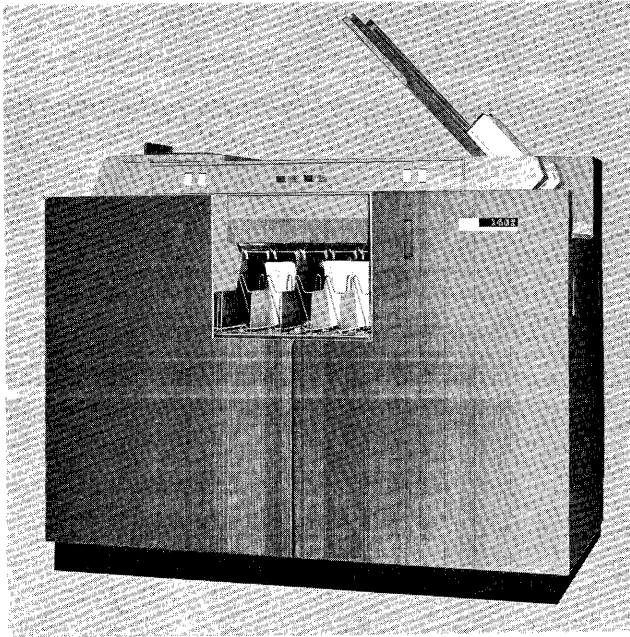

Figure 9. IBM 1402 Card Read-Punch

all 80 columns of the card, for punch checking. At the end of the card transport path on the punch side, three stackers are available to receive the cards. The *normal punch* stacker is used unless the cards are program-directed to stacker 4 or 8. With the addition of punch-feed-read (special feature), the source card can be read in the punch side, and output data can be punched into the same source card.

All these stackers are of the radial type (Figure 11) with a capacity of 1,000 cards each. Cards can be removed from the stackers without stopping the machine. Two stackers are assigned exclusively to the reader and two are assigned exclusively to the punch. The center or *common stacker* (8/2 stacker) can be used by either unit.

Both feeds are equipped with misfeeding- and jam-detection devices. A card jam or a misfeed in either the read or punch feed causes the 1401 to stop. A console light glows, indicating which feed caused the stop.

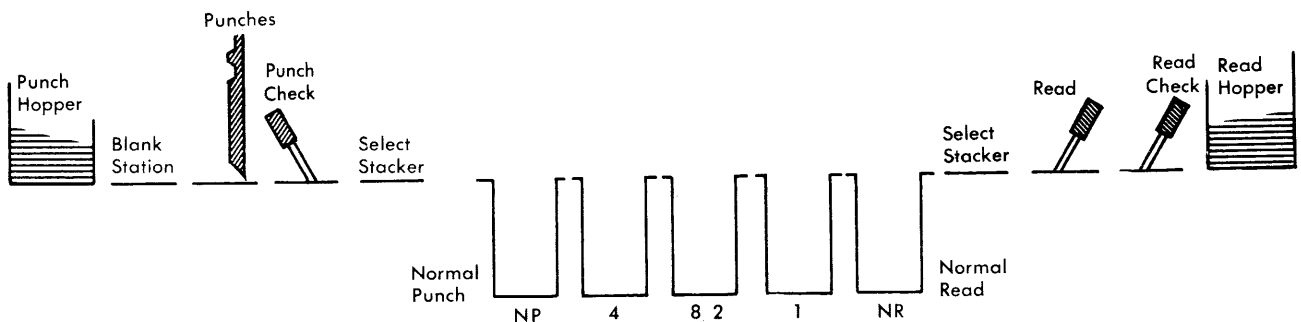

Figure 10. IBM 1402 Card Transport Schematic

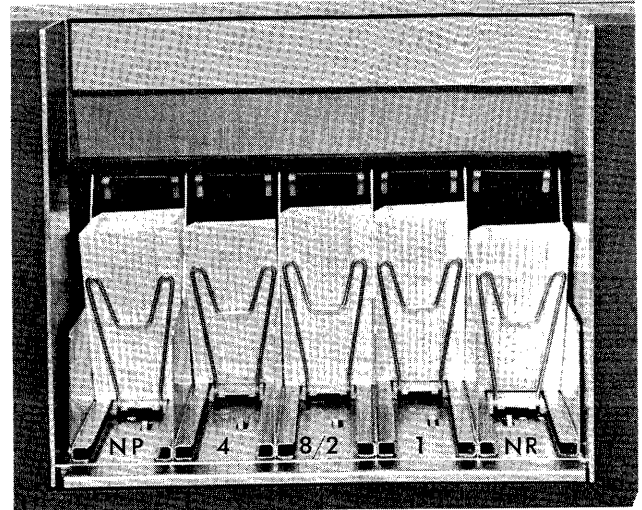

Figure 11. Radial Stackers

No electrical or mechanical coupling exists between the read and punch units. Therefore, any information from the read side must be entered into storage and read out of storage to the punch unit, for operations equivalent to reproducing or gangpunching.

IBM 1403 Printer

The printer (Figure 12) is another output medium for the 1401 card-oriented system. Units of the 1403 have rated printing speeds of 340, 465, or 600 lines per minute, depending on the model. Also, printing capacities of 100, 120, or 132 positions are available.

Horizontal spacing of printed characters is 10 characters to the inch. Vertical spacing of six or eight lines to the inch can be manually selected by the operator. Vertical line spacing is performed by either a single-speed or a dual-speed tape-controlled carriage. (The dual-speed carriage is standard on 1403 printers used in all of the 1401 systems except the 1401 Models A and G systems.)

The dual-speed carriage skips lines at the rate of 75 inches per second after the first eight lines of any skip.

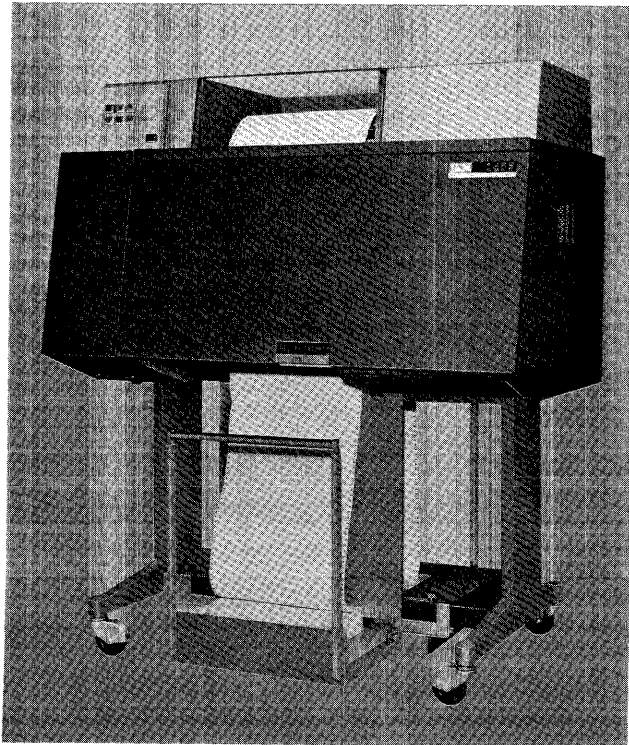

Figure 12. IBM 1403 Printer

The single-speed carriage has a skipping speed of 33 inches per second.

Each position can print 48 different characters: 26 alphabetic; 10 numeric; and 12 special characters (& , . □ - \$ * ≠ / % # @ in special-character arrangement A or B). The printing format is controlled by the 1401 stored program. The information to be printed is checked when it is read out to the printer. The alphabetic, numeric, and special characters are assembled in a chain (Figure 13). As the chain travels in a horizontal plane, each character is printed as it is positioned op-

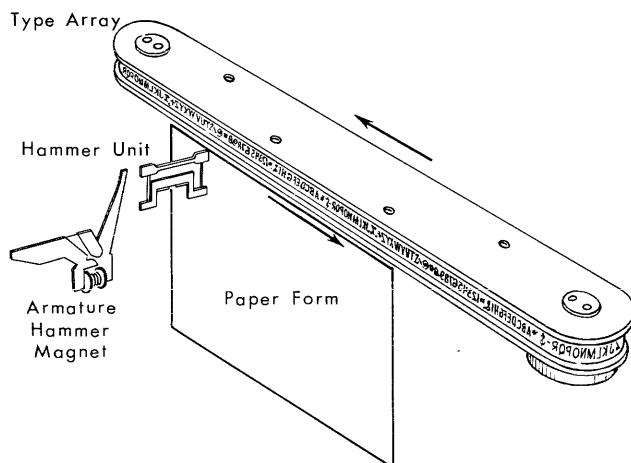

Figure 13. Schematic of Printing Mechanism

posite a magnetically driven hammer that presses the form against the chain.

As each character is printed, checking circuits are set up to insure that the character printed is correct. Checks are also made to insure that only valid characters are printed and that overprinting does not occur. If an error is detected, the machine stops, and the associated check light comes on.

The IBM 1403 Printer has special features that increase operating efficiency. Mobile forms stands allow blank forms to be loaded and wheeled to the printer and completed forms to be wheeled away. This reduces paper handling and job setup time. Forms insertion is simplified by operator control levers and keys.

Interleaving

The 1401 Model G card system can perform a write-and-read or a write-and-punch operation in the time normally required for a read or punch operation (respectively). This simultaneous operation of two units (printer and either reader or punch) is called *interleaving* and is unique to the 1401 Model G.

Write and Read Operation

The write and read operation is performed by executing the print operation during the read start time and card reading time of a read cycle. Depending on the program routine, this operation can result in a card-read speed and printing speed of 450 cards and lines per minute.

Write and Punch Operation

The write and punch operation is performed by executing the print operation during the punch start time and card punching time of the punch cycle. Depending on the program routine, this operation can result in a card-punch and printing speed of 250 cards and lines per minute.

Write, Read, and Punch Operation

The write, read, and punch operation is not completely interleaved. The write and punch portion of the operation is interleaved, and the read operation follows the interleaved operation. This operation results in a printing and card-reading/card-punching speed of 200 cards and lines per minute.

Data Flow

Input to the 1401 card-oriented system is supplied through the 1402 card read-punch, and output from the system is provided through the 1402 card read-punch (punched-card output) and/or the 1403 printer

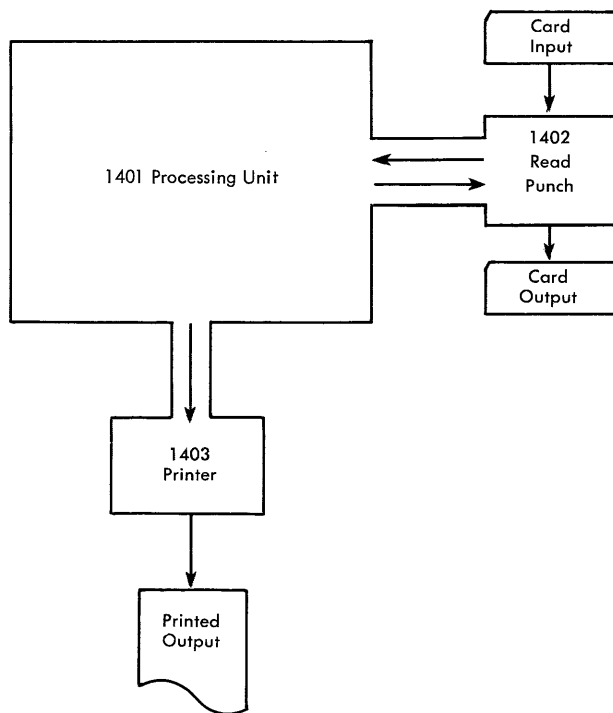

Figure 14. Data Flow (Card System)

(printed output). All input data passes through the 1401 processing unit (where arithmetic and logical functions are performed), and all output data passes from the processing unit to the particular output unit (Figure 14).

Checking

The IBM 1401 Data Processing System contains many important design factors to insure maximum efficiency and reliability. The self-checking features built into the 1401 are designed to insure a high degree of error detection.

Parity Check

The odd-number bit configuration is used for the parity check. The proper number of bits for any given character is known as parity for that character. A word mark that appears with a character is included in the check for an odd number of bits.

When information is moved within the system, a parity check is performed to test the presence of an odd number of bits for each character being moved.

Validity Check

A validity check is performed on all information when it is read into storage from the card reader, to insure that all characters are valid. Any invalid character stops the machine and the associated check light comes on.

Four types of *address validity checking* are performed by the processing unit. Although each of the four checks has a specific function, each check insures that all addresses used in a program are within the core-storage capacity of the system.

Hole-Count Check

The hole-count feature compares the total number of punches read in a card column at the first reading station, with the total number of punches in the same card column at the second reading station. The hole-count feature is also effective with the punch side to compare the total number of holes set up for punching in a column, with the number of holes punched in the card column. If the result of the hole-count comparison is unequal, in either case, the system stops, and check lights indicate the unit involved.

Word Mark

The use of the variable-length instruction and data format requires a method of determining the instruction and data-word length. This identification is provided by a *word mark*.

The word mark serves several functions:

1. It indicates the beginning of an instruction.
2. It defines the size of a data word.
3. It signals the end of execution of an instruction.

NOTE: Word marks are illustrated in this discussion by underlining each character that has an associated word mark.

Stored-Program Instructions

All arithmetic and logical functions are performed by the instructions retained in storage. One form of an instruction consists of an operation code followed by two 3-character addresses. The 2-address instruction is required to move data from one location to another, to perform arithmetic operations of addition or subtraction, to compare two fields, or to edit.

Because the 1401 system uses a variable-word-length concept, the length of an instruction can vary from one to eight characters.

Instruction Format

<i>Op Code</i>	<i>A- or I-address</i>	<i>B-address</i>	<i>d-character</i>
<u>x</u>	xxx	xxx	x

Op Code. This is always a single character that defines the basic operation to be performed. A word mark is always associated with the operation code position of an instruction.

A-Address. This always consists of three characters. It can identify the units position of the A-field, or it can

be used to select a special unit or feature such as tape unit or column-binary feature.

I-address. Instructions that can cause program branches use the I-address to specify the location of the next instruction to be executed if a branch occurs.

B-Address. This is a three-character storage address that identifies the B-field. It usually addresses the units position of the B-field, but in some operations (such as tape read and write) it specifies the high-order position of a record-storage area.

d-Character. The d-character is used to modify an operation code. It is a single alphabetic, numeric, or special character, positioned as the last character of an instruction.

Instruction Example

<i>Op Code</i>	<i>A- or I-address</i>	<i>B-address</i>
<u>A</u>	072	423

This is an ADD instruction. The operation code A causes the field whose units position is in storage location 072 to be added to the field whose units position is in location 423. This operation continues until a word mark for the high-order position of field B (which must have a defining word mark) is sensed. The word mark stops the operation being performed and causes the program to advance to the next instruction. If field A is shorter than field B, it must also have a defining word mark.

As stated before, not all instructions have the 2-address form. Others consist of only one address, or no address. This concept results in what is known as *variable-length instructions*.

Examples of the six combinations possible in variable-length instructions are shown in Figure 15.

Addressing

The 1401 processes data by following a series of stored instructions. The storage unit stores both the instructions and the data. Each position in storage can be addressed. The high-order position of a field in storage is identified by an associated *word mark*.

An *instruction* in core storage is addressed by the location of its high-order position. The machine reads the instruction from left to right until it senses the word mark associated with the next instruction. The final instruction in the program must have a word mark set at the right of the low-order position. The high-order character is the operation code, with an associated word mark that is set by the program when the instruction cards are loaded. In contrast, a *data word* is read from right to left until a word mark is sensed with its own high-order position. In addressing a data word, we specify its units position.

Input/Output Storage Assignments

Certain areas of storage are reserved for use by input/output devices (Figure 16). In most cases, the assignments are such that a correlation is achieved between input/output columns and/or print positions. The storage location assignments are:

001 through 080	card input
101 through 180	card output
201 through 300 (or 332)	print output
334 through 363	IBM 1404 input (special feature)

Except for locations 000 and 100, the areas isolated by these storage assignments can be used for normal processing or instructions. If the read-compare special feature for the 1404 is installed, location 333 is used for internal programming.

NUMBER OF POSITIONS	OPERATION	INSTRUCTION FORMAT			
1	READ A CARD	Op code	<u>1</u>		
2	SELECT STACKER	Op code	d-character	<u>K</u> 2	
4	BRANCH	Op code	I-address	<u>B</u> 400	
5	BRANCH IF INDICATOR ON	Op code	I-address	d-character	<u>B</u> 625 /
7	ADD	Op code	A-address	B-address	<u>A</u> 072 423
8	BRANCH IF CHARACTER EQUAL	Op code	I-address	B-address	d-character <u>B</u> 650 080 4

Figure 15. Instruction Formats

(Shaded portion indicates IBM 1401 Input/Output areas.)
 (White portion indicates area available for program instructions or work areas.)

STORAGE SCHEMATIC-2000 POSITIONS

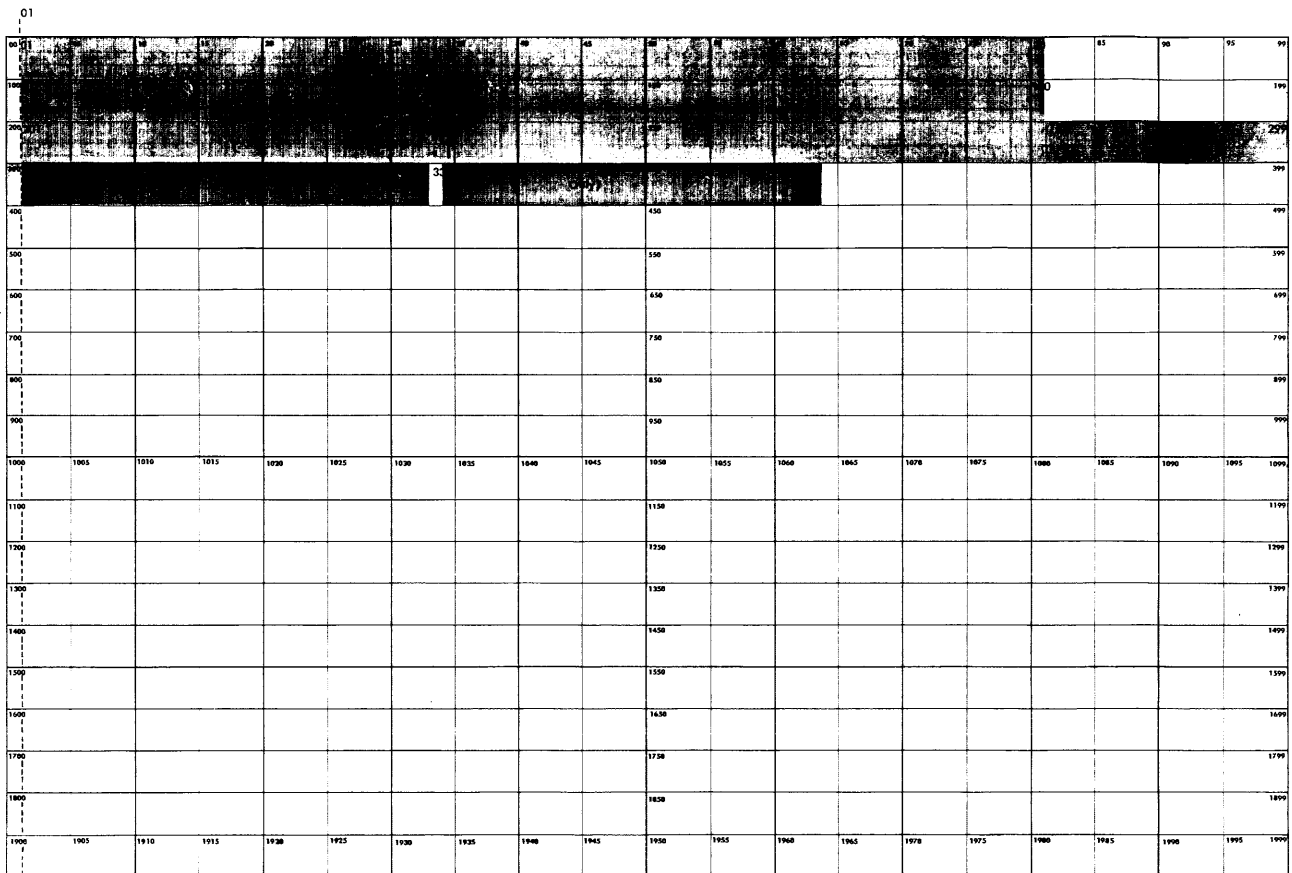

Figure 16. Input/Output Storage Assignments

Address Registers

Four address registers are incorporated in the IBM 1401 Processing Unit. The storage address register specifies the core-storage location that will be involved in a particular storage cycle. The I-, A-, and B-address registers furnish the storage address register with the proper address according to the cycle being executed.

Chaining Instructions

In some programs, it becomes possible to perform a series of operations on several fields that are in sequence in storage. Some of the basic operations, such as add, subtract, move, and load, have the ability to be *chained* so that less time is required to perform the operations, and space is saved in storing instructions. Here is an example of the chaining technique: Assume that four 5-position fields stored in sequence are to be added to four other sequential fields. This operation could be done using four 7-character instructions:

- A 700 850
- A 695 845
- A 690 840
- A 685 835

At the completion of the first instruction, the A-address register contains 695 and the B-address register contains 845. These are the same numbers that are in the A- and B-addresses in the second instruction. Eighty storage cycles would be required to execute these instructions, thus using .920 milliseconds (ms). Also, 28 storage positions are required to store these instructions.

By taking advantage of the fact that A- and B-address registers contain the necessary information to perform the next instruction, this same sequence of operations can be executed:

- A 700 850
- A
- A
- A

Connecting instructions together in this manner is called chaining. The first ADD instruction contains both the A- and B-addresses. The following three instructions contain only the operation code for those instructions. The A- and B-addresses are the results left in the A- and B-address registers from the previous instruc-

tion. This type of operation requires 62 storage cycles and takes .713 milliseconds to execute. Only ten storage positions are required to store these chained instructions.

The ability to chain a series of instructions is not dependent on the use of the same operation code. Chained instructions may have various Op codes. The requirement is that the A-fields to be operated on must be in sequence, and the B-fields must be in sequence.

Example: A 900 850
M
A
M

For example, assume that the data fields are each ten characters long:

The ten characters at location 900 were added to 850.
The ten characters at location 890 were moved to 840.
The ten characters at location 880 were added to 830.
The ten characters at location 870 were moved to 820.

Loading Instructions

Before the 1401 can start processing, program instructions must be put into the system. This is accomplished by means of a loading routine.

Instructions are placed in the machine by the use of load cards or program tapes. Several different types of load cards condition the 1401 to accept information for processing. They cause word marks to be set at specific storage locations, and load a series of instructions that allow the cards containing the actual program instructions to be stored in their correct locations.

Operation Codes

General descriptions of the operation codes for the IBM 1401 are presented here. Detailed descriptions of all Op codes and instructions are found in the *IBM 1401 and 1460 System Operation Reference Manual*, Form A24-3067.

Input/Output Codes

Input/output operation codes control reading and punching data cards, and printing reports. Branching instructions are provided to transfer the program automatically at the completion of a function. More than one function can be initiated by a single instruction.

For example, to cause the 1401 to read card data into core storage and then transfer the program, write this instruction:

<i>Op Code</i>	<i>I-address</i>
<u>1</u>	495 (READ A CARD)

After the card has been read, the program continues with the instruction at storage location 495.

Arithmetic Operation Codes

Add and subtract, and the special multiply and divide operation codes, perform the arithmetic operations. Because the operations are performed within core storage, no accumulators or counters are necessary. Thus, the capacity for arithmetic functions is not limited by predetermined number of counter positions.

Logic Operation Codes

The decision-making ability of the IBM 1401 Data Processing System is based on the logic operation codes. As a result of testing for conditions that can arise during processing, the program can be directed to predetermined sets of instructions, or subroutines.

For example, test the unequal-compare indicator to determine if it is on. If it is off, continue the program with the next sequential instruction. If the indicator is on, transfer the program to location 568 for the next instruction.

<i>Op Code</i>	<i>I-address</i>	<i>d-character</i>
<u>B</u>	568	/ (BRANCH IF INDICATOR ON)

Move and Load Codes

The move and load codes provide program control over the re-arrangement of data in storage and also the transfer of data from an input device into storage.

MOVE instruction transfers data only; LOAD instruction transfers data and associated word marks.

Miscellaneous Operation Codes

These codes perform operations such as selecting stackers, setting and clearing word marks, comparing, and controlling the forms carriage.

Editing

Editing in the IBM 1401 Data Processing System is automatic control of zero suppression, insertion of identifying symbols, and punctuation of an output field. This function can be performed with two simple instructions. One single EDIT instruction can cause all desired commas, decimals, dollar signs, asterisks, credit symbols, and minus signs, to be inserted automatically in a numeric field. Also, unwanted zeros to the left of significant digits are suppressed (Figure 17).

	OP	A-address	B-address
Edit instruction	<u>E</u>	789	300
		A-field (data)	B-field (control word)
Storage		00257426	\$ bbb, bb0.bb & CR & **
			B-field
Result of edit		00257426	\$ 2,574.26 **

Figure 17. Editing

In editing, two fields are needed: the data field, and a control field. The control field indicates how the data is to be edited. It specifies the location of commas, decimals, conditional CR and minus symbols, and indicates where zero suppression is to occur.

The control word is divided into two parts: the body (used for punctuating the A-field) and the status portion (contains the sign symbols and asterisks). Printing sign symbols is, in part, controlled by the sign of the A-field.

To edit a field, a LOAD instruction loads the control word in the output area (B-field); the EDIT instruction moves the data in the A-field to the output area, and performs the editing function.

IBM 1401 Console

The IBM 1401 Console (Figure 18) is designed to give the operator external control for setting up and checking system operation. Several special features are provided to facilitate program testing and debugging.

The background of the console shows the path of data as it moves from one storage area to another including address registers, character registers, and storage addresses.

Special lights indicate operating conditions of the processing, disk, tape, and I/O units and the reader, punch, and printer. If an error is detected while the system is running, a red light comes on to show which unit requires operator attention.

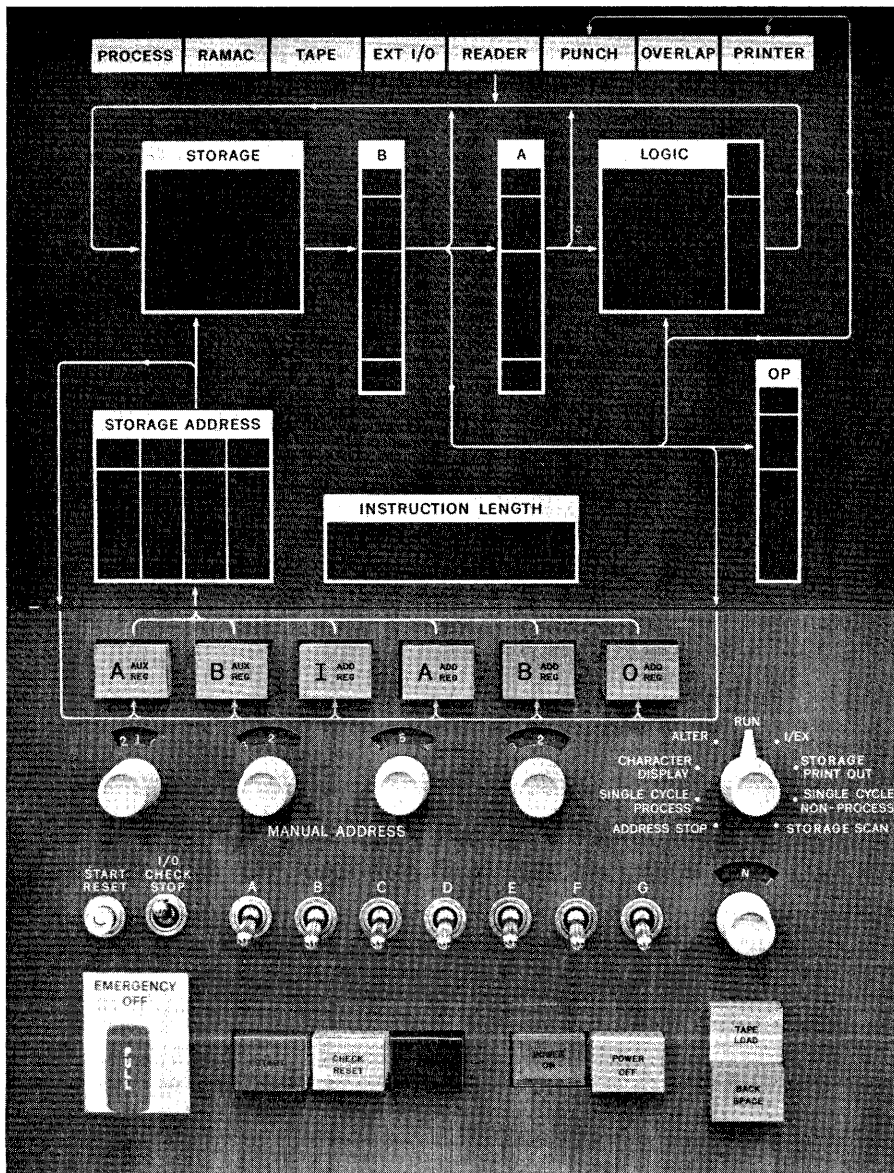

Figure 18. Console, Keys, Lights, and Switches

The operator can display the contents of any storage location at any time during processing. He can also control the course of program execution by setting sense switches to an ON or OFF position, if the program has been designed to take advantage of this flexibility.

The main power supply for the system is controlled by keys located on the console. A special switch is provided to disconnect all power from the system in cases of emergency.

A mode switch facilitates machine operation and program testing by permitting:

1. the operator to stop the execution of the program at a predetermined point. This gives him an opportunity to bypass program steps that have proved accurate and stop at the instruction areas which he would like to examine step by step.
2. single-cycle operation for detailed examination of program functions.
3. display of the contents of a particular storage area.
4. manual change of the contents of any address register or storage location.
5. the contents of storage to be printed with word mark identification.
6. scanning storage for invalid characters.

The auxiliary console (Figure 19), located directly beneath the main console, provides the operator with additional control over the system. It has switches that

are used for program testing, entering data manually, and for selecting the tape density for the IBM 729 v Magnetic Tape Unit. It also has SYNC POINTS that are used by IBM customer engineers.

IBM 1406 Storage Unit

An additional component of the IBM 1401 Data Processing System, the IBM 1406 Storage Unit (Figure 20) makes the 1401 available with core-storage capacity as large as 16,000 positions. This additional storage capacity greatly increases the range of applications that can be handled economically by the IBM 1401.

Faster Processing

Many applications that require two or more passes, because of storage utilization in 1401 with 4,000 positions, can be processed in one pass using a 1401 with increased core storage.

Program Simplification

Programs that would otherwise require intricate programming techniques for full utilization of storage space can be simplified. This means that the speed and efficiency of the total program are increased and the programmer's job is made easier.

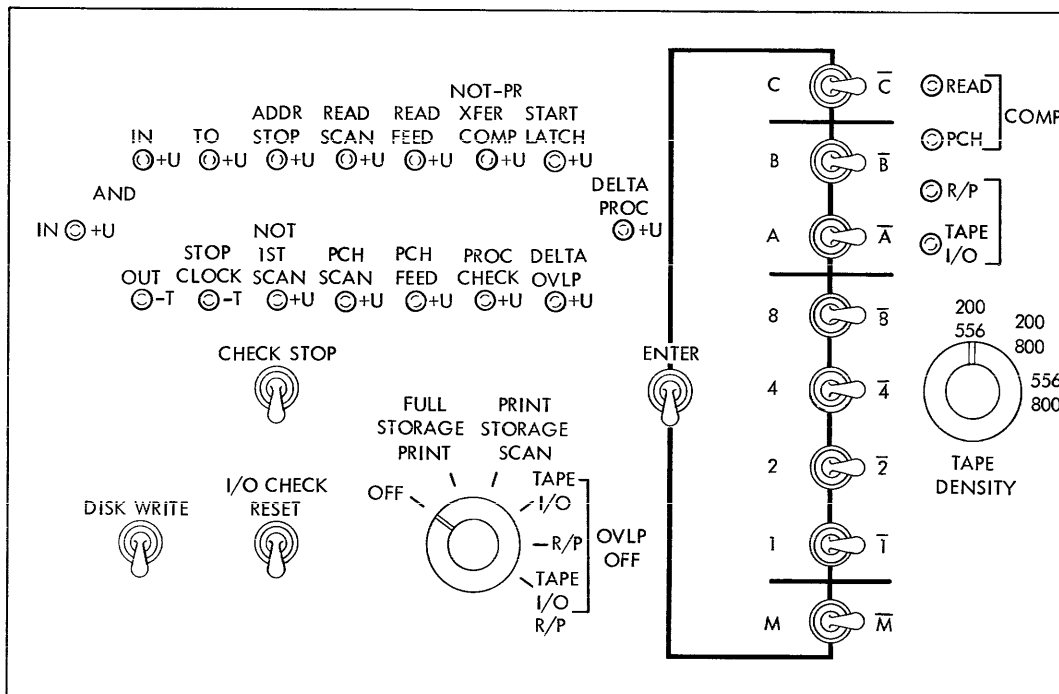

Figure 19. Auxiliary Console

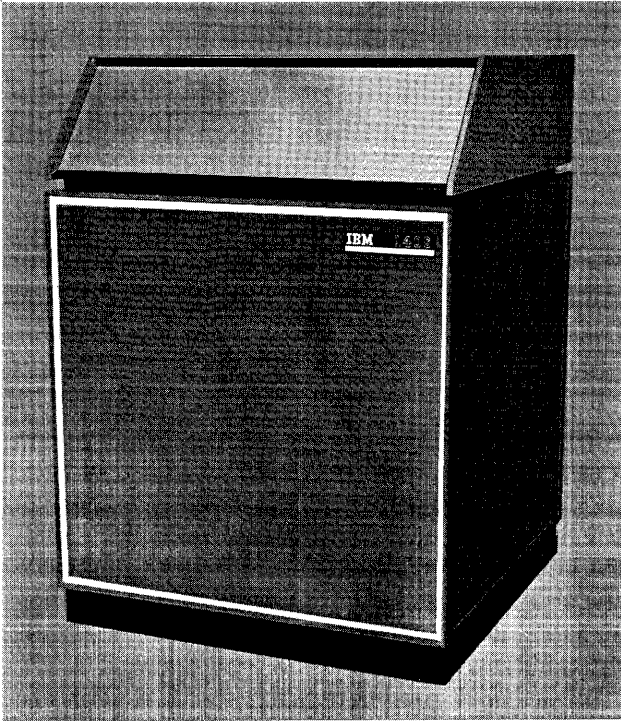

Figure 20. IBM 1406 Storage Unit

Faster Tape Sorting

Because larger blocks of tape records can be read into storage, significant job-time improvements can be realized in magnetic-tape operations including tape sorting, merging, and file maintenance.

Scientific Applications

Most scientific applications are characterized by relatively small amounts of input and output data and complex internal processing. The increased core storage makes it possible to store many of the larger programs, tables, and mathematical subroutines that are required for scientific data processing.

Addressing

When the 1401 has increased core storage, the addressing system is expanded (Figure 21).

The IBM 1401 checks each address to ensure that it is valid for the storage capacity installed. The system stops on an address validity error, if an invalid address is encountered.

ACTUAL ADDRESSES	ZONE BITS OVER HUNDREDS POSITION	ZONE BITS OVER UNITS POSITION	3-CHARACTER ADDRESSES
0000 to 0999 1000 to 1999 2000 to 2999 3000 to 3999	No Zone Bits A-Bit (Zero-Zone) B-Bit (11-Zone) AB-Bits (12-Zone)	No Zone Bits No Zone Bits No Zone Bits No Zone Bits	000 to 999 ≠00 to Z99 !00 to R99 ?00 to I99
4000 to 4999 5000 to 5999 6000 to 6999 7000 to 7999	No Zone Bits A-Bit (Zero-Zone) B-Bit (11-Zone) AB-Bits (12-Zone)	A-Bit (Zero-Zone) A-Bit (Zero-Zone) B-Bit (11-Zone) A-Bit (Zero-Zone)	00≠ to 99Z ≠0≠ to Z9Z !0≠ to R9Z ?0≠ to I9Z
8000 to 8999 9000 to 9999 10000 to 10999 11000 to 11999	No Zone Bits A-Bit (Zero-Zone) B-Bit (11-Zone) AB-Bits (12-Zone)	B-Bit (11-Zone) B-Bit (11-Zone) B-Bit (11-Zone) B-Bit (11-Zone)	00! to 99R ≠0! to Z9R !0! to R9R ?0! to I9R
12000 to 12999 13000 to 13999 14000 to 14999 15000 to 15999	No Zone Bits A-Bit (Zero-Zone) B-Bit (11-Zone) AB-Bits (12-Zone)	AB-Bits (12-Zone) AB-Bits (12-Zone) AB-Bits (12-Zone) AB-Bits (12-Zone)	00? to 99I ≠0? to Z9I !0? to R9I ?0? to I9I

Figure 21. Increased Core-Storage Addressing System

Magnetic-Tape-Oriented System

A card-oriented 1401 system can be expanded to a magnetic-tape-oriented system (Figure 22) to provide low-cost, punched-card and magnetic-tape input and output operations. (Punched-card input and output, however, is not necessarily characteristic of all tape-oriented systems, as is shown by the configuration in Figure 23.) As many as six magnetic tape units can be attached to the IBM 1401 Data Processing System.

The tape-oriented system can be used alone as a complete data processing system. It can be used also as auxiliary equipment for intermediate and large-scale systems, providing economical off-line tape editing and printing.

The logic, arithmetic, editing, and tape instructions of the tape system can be used to perform the primary functions:

- Magnetic tape to printer
- Punched cards to magnetic tape
- Magnetic tape to punched cards
- Punched cards to printer
- Tape sorting and merging

Data Flow

The magnetic-tape-oriented 1401 system has the same data flow (Figure 24) as the card-oriented system (where punched-card input and output are applied),

plus the input into the system from an attached tape unit, and output from the system to an attached tape unit.

All data passes through 1401 core storage, where a series of validity checks ensure accuracy and reliability.

Magnetic Tape

An important feature in economical processing of business data is compact storage. A magnetic-tape reel (10½ inches in diameter) contains 2,400 feet—sufficient tape to record as many as 14,000,000 characters. Tape reels can be stored or transported easily from one installation to another. Also, magnetic-tape records have gained wide acceptance as legal documents.

The magnetic-tape recording code used with the IBM 1401, is the same binary-coded-decimal code used with other IBM data processing systems. This compatibility permits interchanging tapes between installations that employ different IBM systems. The tape itself is a ribbon, ½-inch wide, coated with a magnetic oxide material.

Four models (II, IV, V, and VI) of the IBM 729 Magnetic Tape Unit (Figure 25) can be used with the IBM 1401. All models have dual density; that is, they can write and read either high-density or low-density magnetic tape. Depending on the model, the IBM 729 can

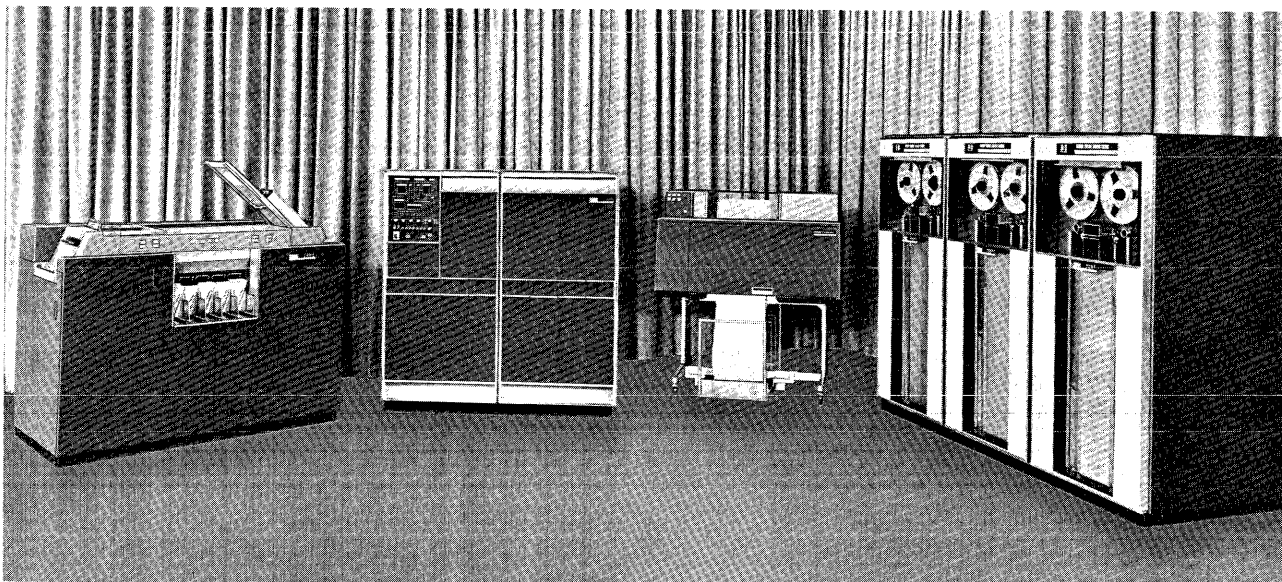

Figure 22. IBM 1401 Magnetic-Tape-Oriented System Model C

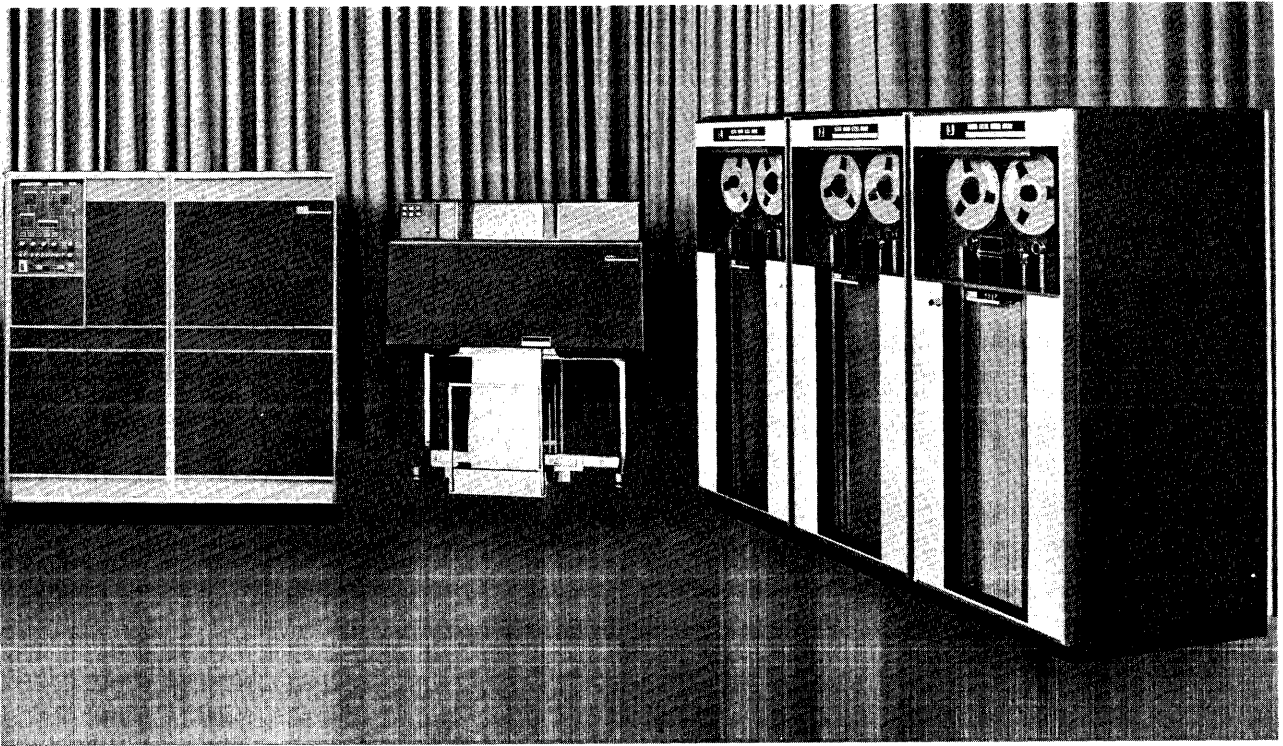

Figure 23. IBM 1401 Magnetic-Tape-Oriented System Model D

write either 200 or 556 characters per inch, or either 200, 556, or 800 characters per inch. (Higher-density tapes provide a significant storage advantage in that fewer reels may be required for a given volume of data.)

In addition to the dual-density feature, all models use a $\frac{3}{4}$ -inch inter-record gap (IRG), and BCD character representation.

The IBM 7330 Magnetic Tape Unit (Figure 26) can be used advantageously in cases where the volume of information is too cumbersome for efficient unit-record processing, and where the tape processing speed is not

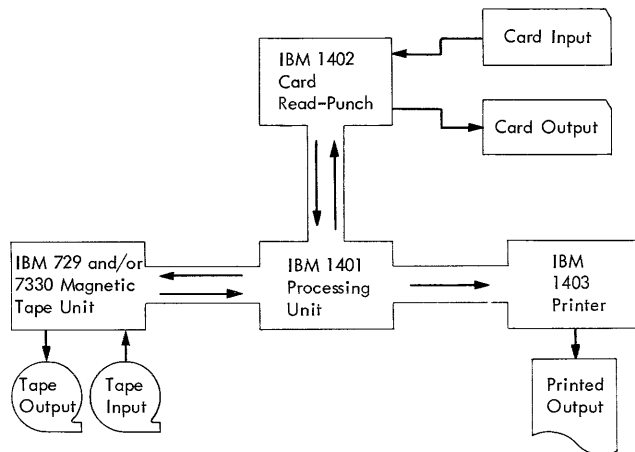

Figure 24. Data Flow (Tape System)

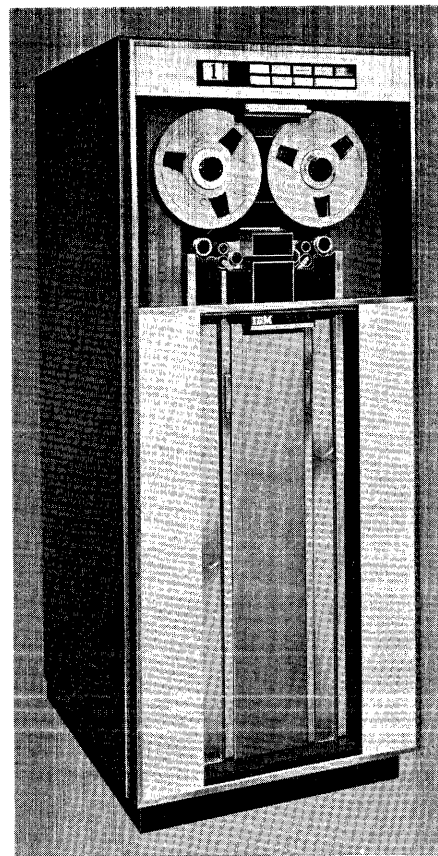

Figure 25. IBM 729 Magnetic Tape Unit

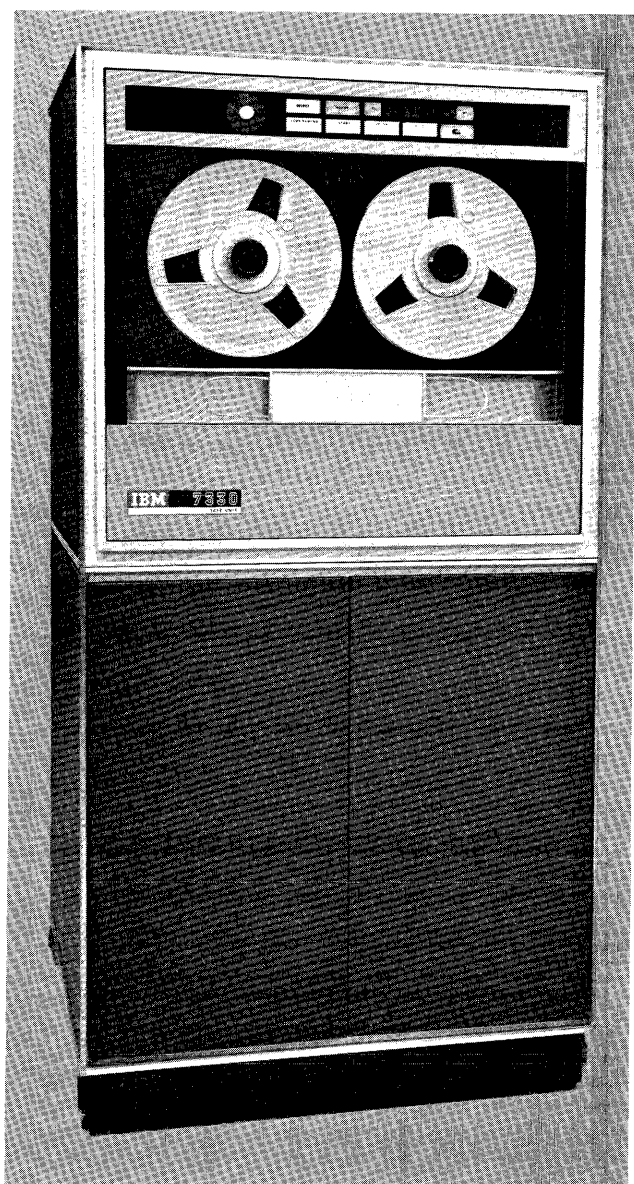

Figure 26. IBM 7330 Magnetic Tape Unit

the major consideration. It has the dual-density feature, the $\frac{3}{4}$ -inch inter-record gap, and the BCD character representation that permit the 7330 to process tapes used in IBM 727 and 729 Magnetic Tape Units, and in the IBM 7701 and 7702 Magnetic Tape Transmission Terminals.

A 1401 system can accommodate as many as six magnetic-tape units. All tape units in a system must be of the same model unless the tape-intermix feature is installed. (See *Special Features* section, *Tape Intermix*.)

The primary difference between the 7330 and the 729 is processing speed. Figure 27 shows a comparison of the five tape units available for use with the IBM 1401 Data Processing System.

Operating Characteristics	729II	729IV 729VI*	729 V	7330
Density, Characters per Inch	200 or 556	200 or 556	200 556 or 800	200 or 556
Tape Speed, Inches Per Second	75	112.5	75	36
Interrecord Gap Size, Inches	$\frac{3}{4}$	$\frac{3}{4}$	$\frac{3}{4}$	$\frac{3}{4}$
Character Rate, Characters Per Second	15,000 or 41,700	22,500 or 62,500	15,000 41,700 or 60,000	7,200 or 20,016
High Speed Rewind,** Minutes	1.2	.9	1.2	2.2
Regular Rewind,** Minutes	6.4	4.3	6.4	13.3

* When used with the IBM 1401, IBM 729VI's operate as 729IV's.

** Speeds are based on a 2400-foot tape reel.

Figure 27. Comparison of IBM 729 and 7330 Magnetic Tape Units

Tape Checking

The IBM 729 and 7330 achieve increased reliability through two features: the *2-gap head*, and *dual-level sensing*. The first of these, the 2-gap head, makes it possible to verify automatically the validity of recorded information at the time it is written. The relative position of the read and write gaps is such that a character recorded by the write gap passes the corresponding read gap almost instantaneously. Thus, as each character of a record is written, it is read and a parity check applied.

If an error is detected, the stored program receives a signal, and a corrective action can be taken. With the 2-gap head, a parity check is detected when the character is written.

The ability of the 2-gap head to read tape in reading and writing operations makes it possible to check these operations by dual-level sensing.

A critical analysis is made of the signal strength of the recorded information. On the basis of this analysis, recorded information is accepted if its signal strength meets fixed standards. If the signal strength does not meet these standards, an error is indicated.

Tape Instructions

When tape units are part of the IBM 1401 Data Processing System, they must be controlled by special tape instructions.

<i>Op Code</i>	<i>A-address</i>	<i>B-address</i>	<i>d-character</i>
<u>x</u>	%xx	xxx	x

Op Code. Signifies the operation code.

A-Address. %xx always appears in the A portion of a 1401 regular tape instruction. The % sign signals that a tape unit is to be selected. The second character can be either U or B depending on whether the tape being read or written is in even- or odd-bit

parity. The third digit specifies the number of the particular tape unit involved.

B-Address. Specifies the location in 1401 core storage of the high-order position of a tape record.

d-Character. Represents the actual operation (read or write).

Example: M(%U2) (419)R. Read the record from tape unit 2 to 1401 core storage in a read tape operation. The high-order tape-record character is moved to location 419, the next character is moved to location 420, etc., until transmission is stopped by an inter-record gap in the tape record, or a group-mark with word-mark in 1401 core storage.

Disk-Storage-Oriented System

The addition of an IBM disk-storage unit expands a card-oriented system or a tape-oriented system to form a disk-storage-oriented system (Figures 28 and 29). Besides affording increased storage capacity, disk-storage for the IBM 1401 Data Processing System permits users to process data on a random basis.

Random accessibility of data is the key to the in-line approach to data-processing. Random access makes it unnecessary to accumulate transactions of a like kind (batching) before entering them for processing. Transactions can be processed as they occur, regardless of their sequence.

Disk storage also permits the storage of subroutines in order to conserve core-storage locations for *working space*. For instance, if, in one program, there are five different subroutines, only as many core-storage locations as are required for the longest subroutine need be reserved for all five. Then, when program conditions dictate, a subroutine can be sought in the disk-storage unit, brought to the reserved area in the processing unit, and executed.

Data Flow

The disk-oriented 1401 system has the same data flow (Figure 30) as the card-oriented/tape-oriented system, plus the input from an attached IBM 1311 Disk Storage Drive, or an attached IBM 1405 Disk Storage unit, and output to the attached drive or unit.

IBM 1311 Disk Storage

In addition to random access of data, IBM 1311 disk storage implements the library concept of disk storage, through the use of disk packs. This concept further extends the flexibility of the 1401 system.

IBM 1316 Disk Packs

The IBM 1316 consists of small disk packs, each capable of storing 2,000,000 characters of information. When recording or reading information, a disk pack (Figure 31) is mounted on an IBM 1311 Disk Storage Drive (Figure 32).

A unique feature of the disk pack is that it can easily be removed from the drive for storage. Therefore,

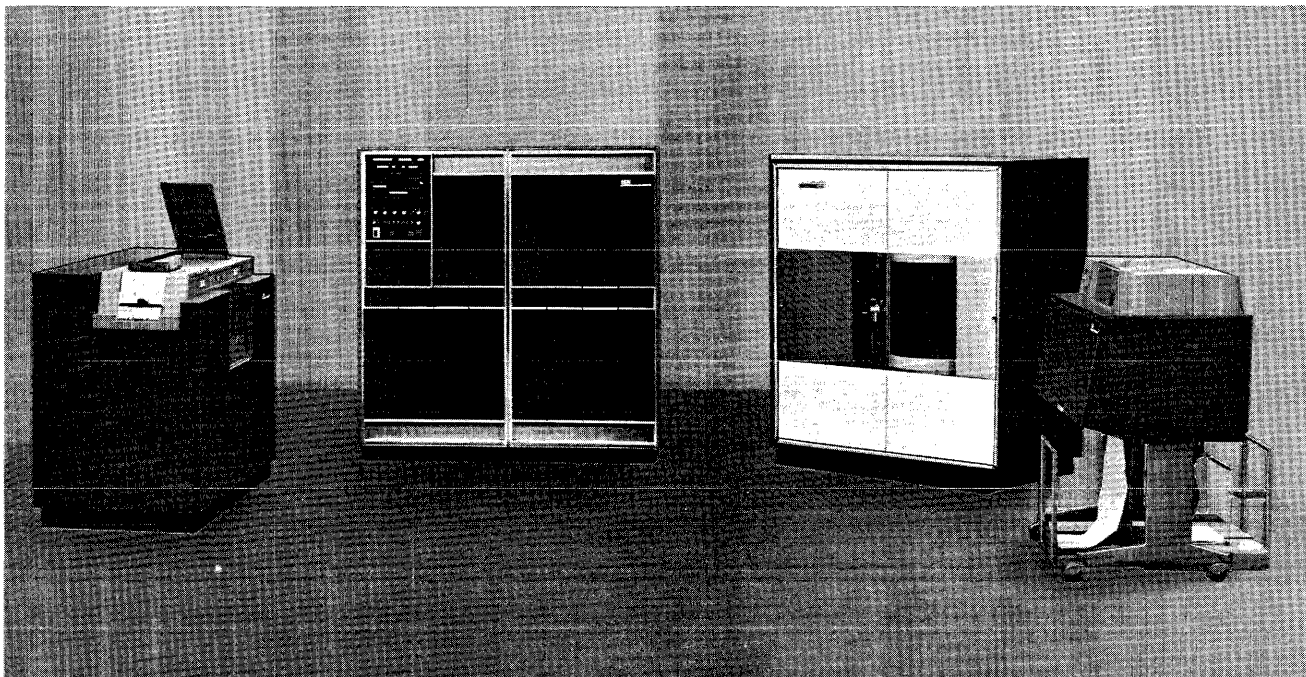

Figure 28. IBM 1401, Using IBM 1405 Disk Storage

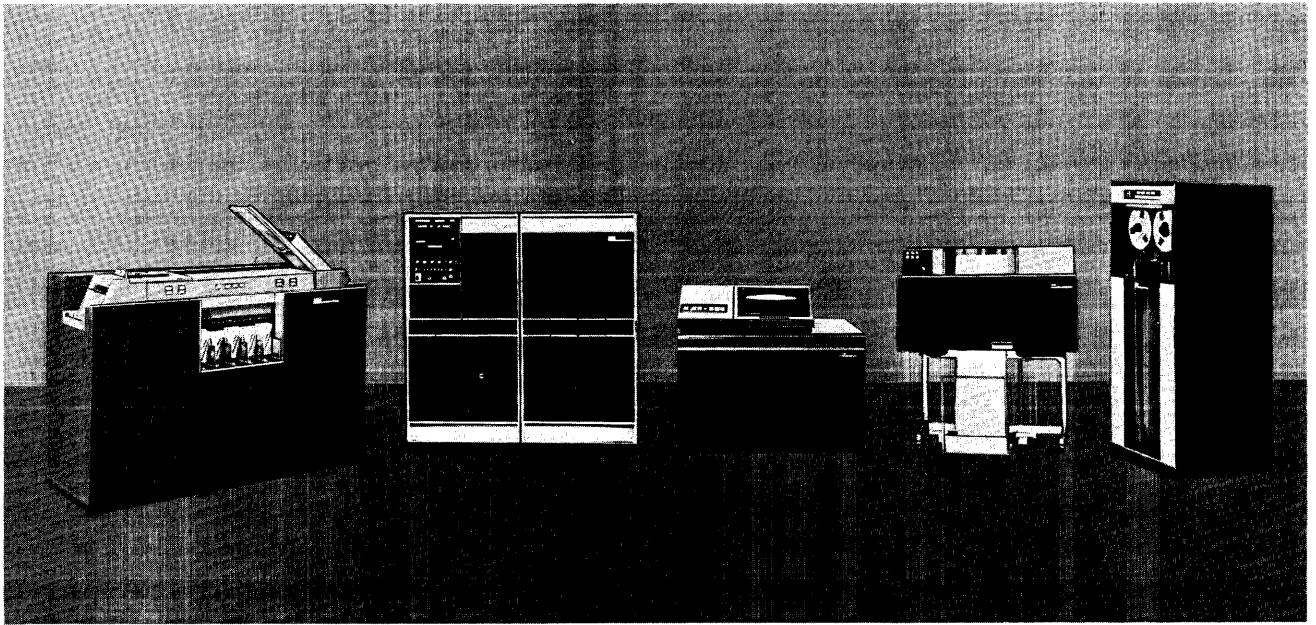

Figure 29. IBM 1401, Using IBM 1311 Disk Storage

when processing is completed for a file of records on a disk pack, that pack can be removed, stored, and another pack mounted. (Disk packs can be changed in less than two minutes.) This same pack can be returned to the system whenever needed.

A disk pack, in its protective container, is 4 inches high, 14 inches in diameter, and weighs less than 10 pounds.

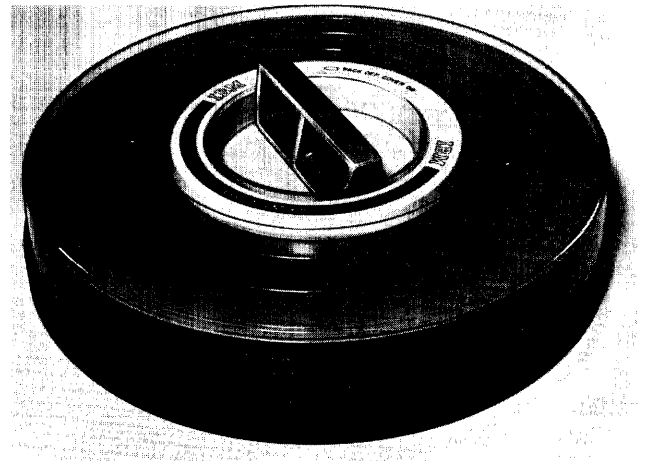

Figure 31. IBM 1316 Disk Pack

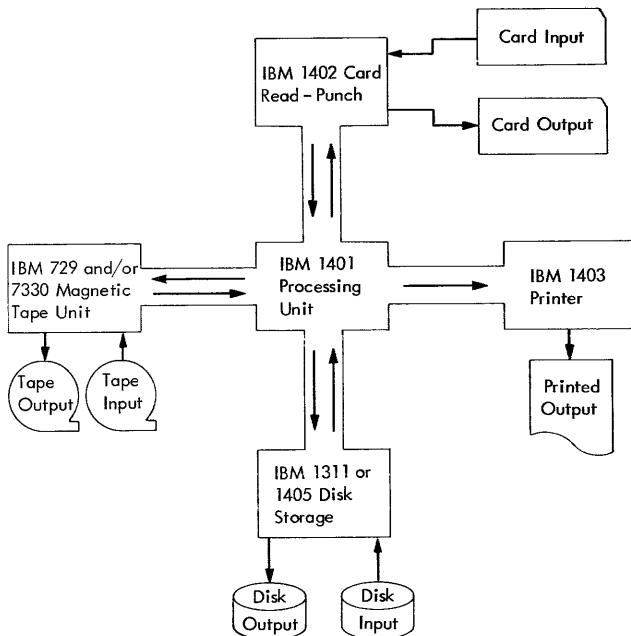

Figure 30. Data Flow (Disk System)

IBM 1311 Disk Storage Drive

Disk packs are read or recorded by an IBM 1311 Disk Storage Drive (one pack at a time per drive). Disks rotate at a speed of 1,500 rpm.

The comb-like access assembly consists of five arms (Figure 33). Each arm contains two heads, each of which can read or write. There is one read-write head for each recordable disk surface. (The very top and bottom surfaces of the disk pack are not used.) The IBM 1311 then can read or write up to ten *vertical* tracks of information at one setting of the access arm. These ten vertical tracks can be thought of as a *cylinder*. The access arms are fixed vertically, so that the only motion required of the arms in the access assem-



Figure 32. IBM 1311 Disk Storage Drive

bly is horizontal, to locate the proper cylinder for any record on the disk pack. There are 100 cylinder positions for the access assembly. The average access time for disk records is 250 ms. When the *direct-seek* special feature is installed, the average access time is 150 ms.

Disk-Storage Addressing

A 6-digit sector address precedes each addressable 100-character location in a disk pack. These numeric addresses are sequential throughout the pack. For example, the addresses of the outer cylinder of the first

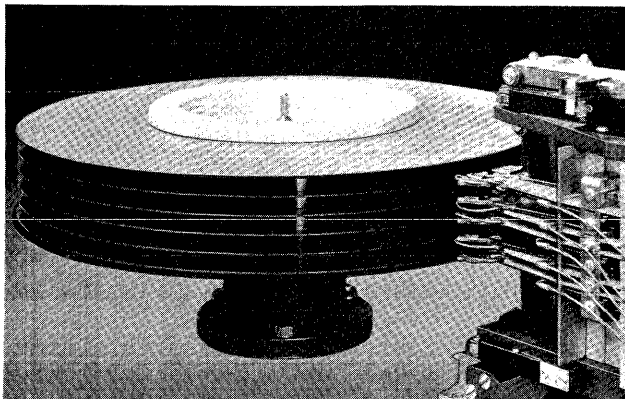

Figure 33. IBM 1311 Access Assembly

pack on a system are 000000-000199. The addresses of the second cylinder of the same pack are 000200-000399, and so on. The addresses of the last (inner) cylinder of the first pack are 019800-019999. When a 1401 system uses five disk drives, the range of addresses is 000000-099999.

Disk Instructions

This is the format of disk-storage instructions:

<i>Op Code</i>	<i>A-address</i>	<i>B-address</i>	<i>d-character</i>
<u>M</u> / <u>L</u>	%Fx	xxx	R/W

Op Code. This is always a single character that defines the basic operation to be performed. M represents a move operation, and L a load operation (includes word marks).

A-Address. %Fx signals that a disk operation is to be performed. The actual operation is determined by the digit in the x-position.

B-Address. This is the high-order position in core storage of the 10-digit disk-control field. A data area in core storage, of sufficient size to contain the data being read into or out of disk storage, must follow the 10-digit field. The data area must be followed by a group mark with a word mark.

d-Character. This character determines whether the disk operation is a read or a write operation.

IBM 1405 Disk Storage

The IBM 1405 Disk Storage (Figure 34) is available in either a 25-disk unit or a 50-disk unit. On each disk there are 200 tracks, each capable of containing ten 200-character records. The total capacity then of the 25-disk unit is 10 million alphabetic and/or numeric characters, and the capacity of the 50-disk unit is 20 million alphabetic and/or numeric characters. Only one 1405 may be attached to an IBM 1401 system.

The IBM 1405 has one standard access arm. Another is available as a special feature. The access arm is forked, and has two read-write heads enabling the arm to read and record data on both surfaces of a disk.

Disks rotate at a speed of 1,200 rpm. Data is read or recorded at the rate of 22,500 characters per second. Access time is 100 milliseconds minimum, and 800 milliseconds maximum.

Disk-Storage Addressing

Each sector has an indelible 7-digit disk address preceding the 200-character record area. Disk records are arranged sequentially in ascending order from bottom to top of the disk-storage unit. The disk address of the first record in the outside track of the bottom disk is

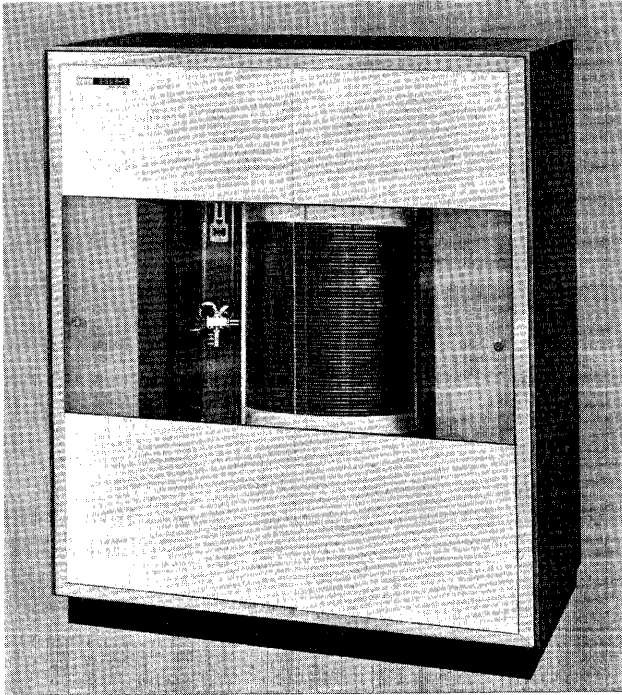

Figure 34. IBM 1405 Disk Storage

X0000000 (X specifies the access arm). The last address of the last record in the inside track of the top disk is X0999990.

Disk storage address format:

Access Arm	Disk Unit	Disk Face	Track	Sector	Constant
x	x	xx	xx	x	x
0-1	0	00-99	00-99	0-9	0

Disk Instructions

Disk operations are initiated by an instruction format similar to magnetic-tape read and write.

Op Code	A-address	B-address	d-character
<u>x</u>	%Fx	xxx	x

Op Code. This is always a single character that defines the basic operation to be performed.

A-Address. %Fx always appears in the A portion of the

1401 disk-storage instruction. The actual operation is determined by the digit in the x position.

B-Address. Specifies the high-order position in core storage of the 8-character disk address.

d-Character. Used to modify an operation code. It is used to test indicators or to specify a read or write operation.

IBM 1407 Console Inquiry Station

The IBM 1407 (Figure 35) provides a fast, direct, manually controlled means of communication between the operator and any model of the IBM 1401 Data Processing System. Using an instruction format, the 1407 can control both reading from, and writing into, storage. It permits the 1401 system user to either examine or alter the status of a particular account, record, or instruction stored in the system.

This feature is especially useful in a disk-storage-oriented 1401 system, where information such as customers' accounts, stock status data, and payroll details are kept categorically. Through the 1407, the operator can request specific data from any disk record, and have the information automatically typed seconds later. This typed copy also serves as a log of information entered into, or received from, a 1401 via the inquiry station.

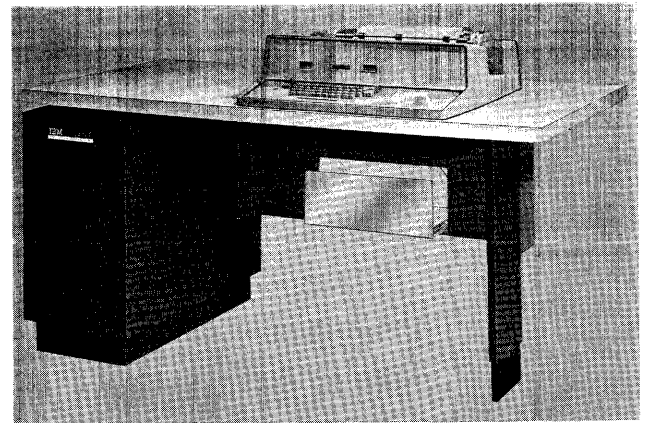

Figure 35. IBM 1407 Console Inquiry Station

Special Features

When application coverage or processing conditions require more program flexibility and faster program execution, special features can be added to an IBM 1401 Data Processing System.

Each special feature contributes to the efficiency of the total system by providing one or more of these advantages:

1. system compatibility between the IBM 1401 and other IBM data processing systems
2. increased speed
3. simplified programming
4. additional system capacity
5. simplified system organization

The special features are listed according to the IBM 1401 functional unit to which they apply.

IBM 1401 Processing Unit

Advanced Programming Features

Indexing

In 1401 programming, many applications require that the same operations be performed repetitively, with a change only in the A- or B-address. Modifying these addresses each time a repetitive operation is performed requires several program steps, plus additional storage locations that must be set aside for this use.

Three index locations are provided in the IBM 1401 Processing Unit to modify addresses automatically. This means that fewer instructions are needed, which in turn means that additional storage space is made available. This permits faster execution of a program, and an over-all simplification of programming effort.

Store Address Register

This feature makes it possible to store the contents of the A- and B-address registers after any operation. It is particularly useful when fields or records of variable length are being processed, or when a method of linking a main routine with a subroutine is desired. For example, the address of the next sequential instruction is stored in the B-address register after a program branch to the I-address occurs. If the first instruction of the subroutine stores the contents of the B-address register in the last step of the subroutine (unconditional

branch instruction), the program will branch back to the next instruction in the main routine after the subroutine has been executed.

Move Record

This special feature can be installed when the 1401 also has the Indexing feature. A special operation code makes it possible to move two or more fields that comprise a complete record in storage, disregarding word marks within the record. The operation causes the record to be moved serial-by-character from left to right, until a record mark or group-mark with word-mark is sensed in core storage. This feature increases program efficiency, because only one instruction is needed to move several sequential fields.

Bit Test

This feature is a BRANCH instruction that causes the character located at the B-address to be compared, bit by bit, with the d-character. If any bit in the character located at the B-address matches any bit in the d-character, the program branches to the specified I-address (WM and C-bits are not compared).

High-Low-Equal Compare

This special feature causes the compare instruction to store the results of a comparison in indicators that can be tested for high, low, or equal conditions.

This feature provides speed and flexibility in tape-sorting operations. A control number in storage can be used to determine the sequence of records that have been read from tape.

Multiply-Divide

Although multiplication and division can be programmed for the IBM 1401, in cases where applications require a significant amount of calculating, the direct multiply-divide feature greatly increases processing speed and conserves storage space.

Processing Overlap

By permitting the 1401 system to process data while conducting input or output operations, this feature provides full use of high-speed processing and input/output capabilities. With this feature, the system continues to compute while the I/O unit prepares to send or receive data, and continues to compute between

character transfers. Actually, processing is interrupted, so that input or output cycles can be taken. A character can be read, written, punched, transmitted, or received between processing cycles. Thus, job time is reduced through increased efficiency. The time saved varies not only with the specific application, but also with the input/output requirements of the program.

Sense Switches

Seven sense switches can be included on the IBM 1401 Processing Unit. The manual toggle switches that control them are located on the console. Switch A is used to control last-card operations. It is standard in all systems except Model D. Six additional sense switches (B, C, D, E, F, and G) are available as special features. These are used for external control over the course of the stored program.

Expanded Print Edit

This feature provides additional editing capacity when printed documents contain fields that require special punctuation including asterisk protection, floating dollar sign, decimal control, and sign control left.

Asterisk Protection

In applications such as check-writing, it is often necessary to have asterisks appear at the left of significant digits, to prevent alteration of figures and amounts. The asterisk-protection feature causes multiple asterisks to be printed as specified by an asterisk written at the left of the zero suppression code in the edit control word.

Floating Dollar Sign

When a control word is written with the \$ at the left of the zero suppression code, a dollar sign is inserted in the position at the left of the first significant digit in a printed amount field. By using this method of punctuation, amount fields used in records, such as checks and bills, cannot be easily altered because there is no space between the dollar sign and the first significant digit.

Sign Control Left

Whenever CR or minus symbols must be printed at the left of a negative field, the sign-control-left feature is used. The appropriate negative sign is written in the high-order position of the control word. The sign of the field being edited is examined, and the CR or minus sign is inserted whenever the amount is negative.

Decimal Control

This feature ensures that decimal points print only when there are significant digits in the field being edited.

Print Storage

This feature provides 100 or 132 non-addressable extra positions of core storage that are used as temporary storage for data to be printed, and releases nearly all of the normal interlocks during print time. After the transfer to print storage is complete, the 1401 is free to perform other operations because actual printing involves only the print-storage area and the IBM 1403 and 1404 Printers. Thus, available processing time is greatly increased for applications characterized by a high volume of printing.

Space Suppression

Normally, the IBM 1403 and 1404 Printers take an automatic space after printing a line. With this feature, the d-character S, when used with any printer instruction (operation codes 2, 3, 6, or 7), suppresses this automatic space. The next print instruction causes printing on the same line.

Read Punch Release

During reading and punching operations in a standard 1401, there is a 21-millisecond read-start-time interlock, and a 37-millisecond punch-start-time interlock, during each complete read or punch cycle. The read-release and punch-release special feature provides two operation codes that are used to release the read and punch start time interlocks, and make extra time available for processing during read and punch cycles.

Column Binary

This feature makes it possible to process cards and magnetic-tape data recorded in column binary form. This provides compatibility between the IBM 1401 Data Processing System and IBM scientific data processing systems such as the IBM 704, IBM 709, and the IBM 7090.

Auxiliary operations that can be performed for large-scale binary systems are:

1. card to tape
2. tape to card
3. card to card
4. tape to tape
5. card to printer
6. tape to printer
7. tape sorting, editing, and merging
8. file maintenance.

Compressed Tape

With this special feature, the 1401 can read compressed tape prepared by the IBM 7070 Data Processing System, and can expand it within storage to enable the 1401 stored program to process it. A compressed tape record is written by the 7070 by means of the `WRITE WITH ZERO ELIMINATION` instruction. With this operation, as many as five high-order zeros from each numerical word in storage are not recorded on tape, thus saving tape capacity and read-write time (alphabetic data is not compressed).

800 CPI (Characters per Inch)

IBM 729 v Magnetic Tape Units attached to a system normally operate at either 200 or 556 characters per inch. With the 800 CPI feature, the 729 v can operate at three different densities. A tape density switch on the auxiliary console determines whether the 729 v operates at 200/556, 200/800, or 556/800 characters per inch.

Tape Intermix

This feature makes it possible to have IBM 729 II, IV, V, VI and 7330 Magnetic Tape Units, in any combination, connected to the same 1401 system. Thus, the most suitable tape units are available for the job to be done. For instance, some jobs require a pair of high-speed tape units (such as 729 IV's); other operations can be done on slower units (such as 7330's). With tape intermix, any combination of tape units can be available to meet the requirements of a particular application.

Serial Input/Output Adapter

This special feature is required to attach these components to a 1401 system:

- IBM 1009 Data Transmission Unit
- IBM 1011 Paper Tape Reader
- IBM 1012 Tape Punch
- IBM 1231 Optical Mark Page Reader
- IBM 1285 Optical Reader
- IBM 1412 Magnetic Character Reader
- IBM 1418 Optical Character Reader
- IBM 1419 Magnetic Character Reader
- IBM 1428 Alphameric Optical Reader
- IBM 1445 Printer
- IBM 7710 Data Communication Unit
- IBM 7340 Hypertape Drive Model 2
- IBM 7740 Communication Control System Direct-Data-Channel feature

The same adapter accommodates all 14 units, but only one can be attached at a time.

Direct Data Channel

This special feature permits the interconnection, through their serial input/output adapters (special feature), of two 1401's or of a 1401 and a 1440.

IBM 1402 Card Read-Punch

Early Card Read

Normally, if processing time exceeds 10 milliseconds in a basic card-read cycle, the rated card-reading speed decreases. This occurs because there is only one time during the read cycle when the feeding mechanism can engage. With the early-card-read feature for the 1402, two additional clutch points permit the feeding mechanism to engage sooner. This minimizes the decrease in card-reading speed caused by lengthy processing routines.

Interchangeable 51-Column Read Feed

The interchangeable 51-column read feed (including file feed) permits feeding either 51-column cards or standard 80-column cards in the read feed of the IBM 1402 Card Read-Punch.

The 51-column card is commonly used for charge sales slips, postal money-order forms, installment payments, inventory cards, and many other applications.

Using an interchangeable feed allows direct entry to the data processing system from the stub card. This makes it unnecessary to reproduce 51-column cards into standard 80-column cards.

Punch-Feed Read

This special feature provides the ability to punch output data into the same card from which the input data was read. The punch feed in the IBM 1402 Card Read-Punch is modified by adding a set of 80 reading brushes one station ahead of the punch station (Figure 36). The card at the punch-feed read station is read while the card ahead of it is being punched. The information read from the punch-feed read brushes enters into 1401 storage addresses 001-080 in the same manner as information read in the read feed. A validity and a columnar hole-count check is made on each column that is read from the punch-feed read brushes.

The punching operation for punch-feed read is the same as in the basic 1401 storage positions 101-180. A hole-count check is also made at the punch check brushes.

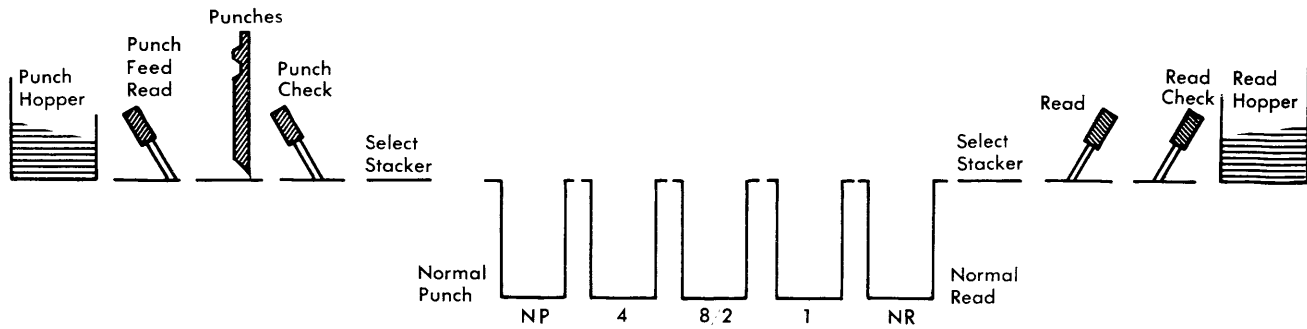

Figure 36. IBM 1402 Card Transport Schematic with Special Punch-Feed Read Station

IBM 1403 and 1404 Printers

Auxiliary Ribbon Feeding

This feature is recommended for satisfactory utilization of polyester film ribbon and can also be used for conventional fabric ribbons. This feature and the polyester film ribbon are recommended when the IBM 1403 is used to prepare paper documents heavier than 24-pound stock for optical character recognition on the IBM 1418 Optical Character Reader or IBM 1428 Alphameric Optical Reader.

Interchangeable Chain Cartridge Adapter

Many applications require distinctive type styles for particular printing jobs. This special feature for the IBM 1403 and 1404 Printers allows chain cartridges to be changed quickly according to the printing requirements of the job. This is accomplished simply by the placing one chain cartridge with another that has a different type font, type style, or special-character arrangement.

Numerical Print

This feature for the IBM 1403 Printer is designed for those businesses with certain 1401 applications that require no alphabetic printing. With this feature, the time required to produce numeric reports can be reduced by as much as one-half.

By changing the chain cartridge in the 1403, the system's user can switch from the alphameric to the numeric mode. The numeric chain is composed of 15 character sets, with 16 characters (0 through 9 \$. , * - □) in each set. In the numeric mode, the 1403 can print 1,285 lines per minute—more than twice as fast as in the alphameric mode.

Read-Compare

This special feature permits reading and comparing data from punched cards in the feed of the IBM 1404 Printer. A control panel enables the operator to select

any 30 of the 160 available card columns. These 30 positions are assigned storage locations 334 to 363. The 1401 COMPARE instruction compares data in the assigned read-in area with data in any other core-storage area.

Selective Tape Listing

This special feature increases the use of the IBM 1403 Printer in applications (primarily banking) requiring adding-machine tape listings. Combinations up to eight 1½" tapes or four 3½" (double-width) tapes can be accommodated on the IBM 1403, Model 2. The permanently mounted tape-advancing mechanism does not interfere with normal form-feeding operations.

IBM 1405 Disk Storage

Additional Access Arm

To reduce access time in IBM 1405 disk-storage applications, an additional access arm can be attached to the IBM 1405 Disk Storage. One arm can be used for seek instructions, involving one section of storage or one group of records, while the additional arm can be used for another section or group.

IBM 1311 Disk Storage Drive

Direct Seek

Standard operation of the 1311 provides for the access mechanism to return to its home position before seeking another cylinder position. The *direct-seek* feature, however, reduces record access time by allowing the access mechanism to move directly to a new setting without first returning to the home position.

Scan Disk

This feature provides the system with the ability to make a rapid search of a disk pack for a specific code

or condition (such as date or account number) stored within the data itself. The *scan-disk* feature is valuable for table lookup operations, and for operations that require matching transaction records with master records in disk storage.

Only one `SEEK` and one `FILE SCAN` instruction are required to cause the program to search through an entire cylinder (200 records). The program can be directed to search (scan) all records in a file, or all records in a cylinder, or any specific number of records.

Seek Overlap

When this feature is installed on the IBM 1311 Disk Storage Drives of a 1401 system, it permits overlapping a 1311 read or write operation with seek operations on the other attached 1311 drives. On a 1401 system

equipped with five 1311 drives, for example, one drive can be reading or writing while the other four 1311 drives can be executing a seek operation. No special machine instructions are required to use this feature.

Track Record

Normally, a record is written on one or more 100-character sectors of a track. The *track-record* feature, however, permits writing *one* 2,980-character record on a track. (If data containing word marks is written on the track, the capacity of a track is 2,682 characters.) Thus, the capacity of a disk pack is increased from 2,000,000 characters to 2,980,000 characters when this feature is installed.

A disk pack can contain records written in the *track-record* manner or in the *sector* (normal) manner.

Other Input/Output Units for the IBM 1401 System

The attachment of other units expands the capabilities of the IBM 1401 Data Processing System. Tele-processing units speed direct communication between installations. Banking equipment permits rapid introduction of data directly from source documents. Other units make the 1401 more productive by increasing input or output speeds, expanding capabilities, or by simplifying manual chores.

For detailed information on these units, see the appropriate publications listed in *IBM 1401 and 1460 Bibliography*, Form A24-1495, and *IBM Tele-processing Bibliography*, Form A24-3089.

IBM 1009 Data Transmission Unit

The 1009 (Figure 37) permits high-speed 2-way communication between two IBM 1401 Data Processing Systems, between a 1401 and an IBM 7701 Magnetic Tape Transmission Terminal, between a 1401 and an IBM 7702 Magnetic Tape Transmission Terminal, or between a 1401 and an IBM 1013 Card Transmission Terminal.

With this unit, a 1401 system can transmit at speeds up to 300 characters per second over toll or leased communications-company lines. This information can be sent short distances between local plants, or long



Figure 37. IBM 1009 Data Transmission Unit

distances across the country—all under stored-program control.

With the buffer feature installed, the over-all system performance is improved because the system can process while the buffer sends or receives information. Processing is suspended only during the transfer of data between core storage and the buffer.

IBM 7710 Data Communication Unit

The 7710 (Figure 38) furnishes the same communication capabilities as those of the 1009. In addition to the line speeds of the 1009 (150, 250, or 300 characters per second) on voice-grade communication services,

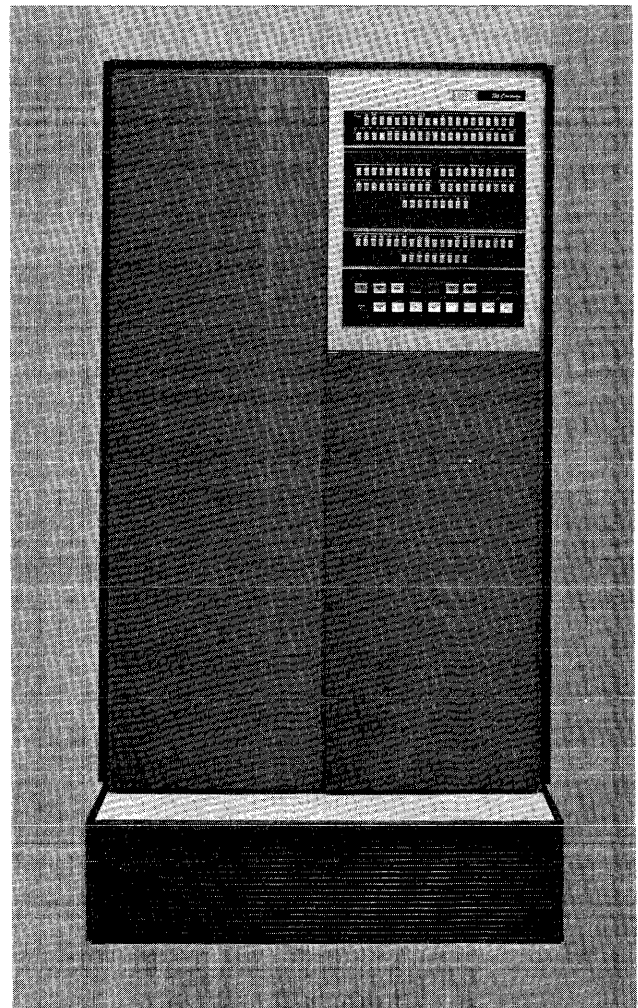

Figure 38. IBM 7710 Data Communication Unit

the 7710 also provides a much higher line-speed rate (5,100 cps) on broad-band communication services (such as microwave and coaxial cable).

IBM 7740 Communication Control System

The IBM 7740 Communication Control System supervises a communication network by polling and addressing terminals, and by checking communication lines. It performs the work of manual, torn-tape, automatic, or semi-automatic switching systems. The system can utilize any message header format. It virtually eliminates input queries while efficiently controlling and maintaining output queries.

The 7740 provides message protection by sequence numbering, logging, and error checking. It permits various types of terminals to communicate with each other. The system automatically answers and calls remote terminals, and can operate independently of a data processing system.

The 7740 attaches to the 1401, 1410, 1440, 1460, or any 7000 series (except 7072) data processing system. The system can communicate with another IBM 7740, 65 or 66, 1050, 1060, 1009, 1013, 7701 or 7702, 7710, 7711, an IBM System/360, and other appropriate commercially available telegraph terminal equipment.

IBM 7770 Audio Response Unit

The 7770 (Figure 39) provides audio response to digital inquiries to the processing system. These inquiries are made from a telephone-type terminal, the IBM 1001 Data Transmission Terminal, or other similar terminals. The audio response is composed from a pre-recorded vocabulary on a magnetic drum in the IBM 7770. Connection between the inquiry terminals and the IBM 7770 is made via appropriate common-carrier data sets and switching equipment. This unit is attached to the processing system through the IBM 1311 file-control channel.

IBM 1026 Transmission Control Unit

Transmission control is the nucleus of any communication system made up of a number of terminals, leading to a central location. The IBM 1026 Transmission Control Unit (Figure 40) is an economical means of entering numeric, alphabetic, and special-character data directly into a 1401 system from a half-duplex, multipoint communication line.

An IBM 1026 can serve terminals of various speeds:

1. IBM 1030 Data Collection System (60 characters per second—cps).

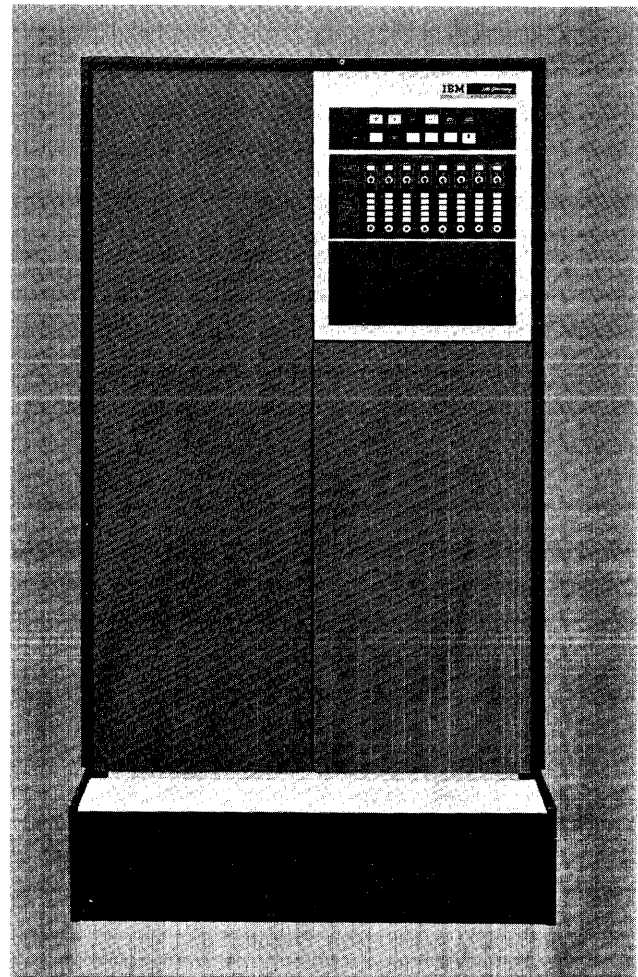

Figure 39. IBM 7770 Audio Response Unit

2. IBM 1050 Data Communications System (14.8 cps).
3. IBM 1060 Data Communications System (14.8 cps).
4. IBM 357 Data Collection System with IBM 1408 Transmission Unit (60 cps).
5. IBM 1070 Process Communication System (66.6 cps).

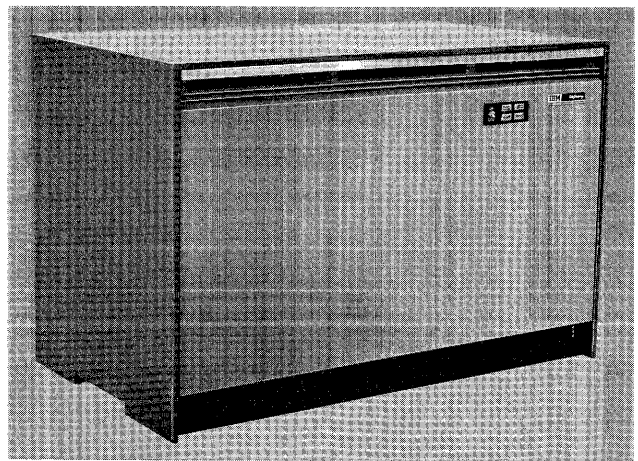

Figure 40. IBM 1026 Transmission Control Unit

The IBM 1026 directs and regulates the flow of data, and provides compatibility among terminals and processing and exchange units.

IBM 1011 Paper Tape Reader

Punched paper tape is an ideal medium for recording information from source readings, data transmission, and data collection sources. Information punched into paper tapes can be transmitted quickly and inexpensively (by IBM Tele-processing equipment) from remote locations to punching equipment at a central data processing location. The IBM 1011 Paper Tape Reader (Figure 41) reads information from punched paper-tapes into a 1401 system.

The IBM 1011 can read characters from a 5-track telegraphic tape or 8-track IBM tape at a rate of 500 tape characters per second.

IBM 1012 Tape Punch

Punched tape is an ideal medium for recording data to be transferred between data processing locations, and to be used in controlling automated machine tools such

as point-to-point drilling machines, continuous-path contouring machines, and automated drafting equipment. The IBM 1012 Tape Punch (Figure 42) is available to provide such punched-tape output from a 1401 system.

The IBM 1012 can punch either 5-, 6-, 7-, or 8-track paper tapes, or Mylar* tapes, under control of a stored 1401 program at a rate of up to 150 characters per second.

The read special feature enables the IBM 1012 to operate as a reader also. The mode of operation (read or punch) is then controlled by a special read/punch switch installed on the IBM 1012.

IBM 1231 Optical Mark Page Reader

The IBM 1231 (Figure 43) provides the means for recording data from source documents in any application where the record of positional marks on an 8½" x 11" document is suitable. Schools, colleges, business, and governmental institutions find the IBM 1231 particularly appropriate because they administer objective tests to measure academic achievement, mental traits, and vocational interests.

*Trademark of E. I. du Pont de Nemours Company Inc.

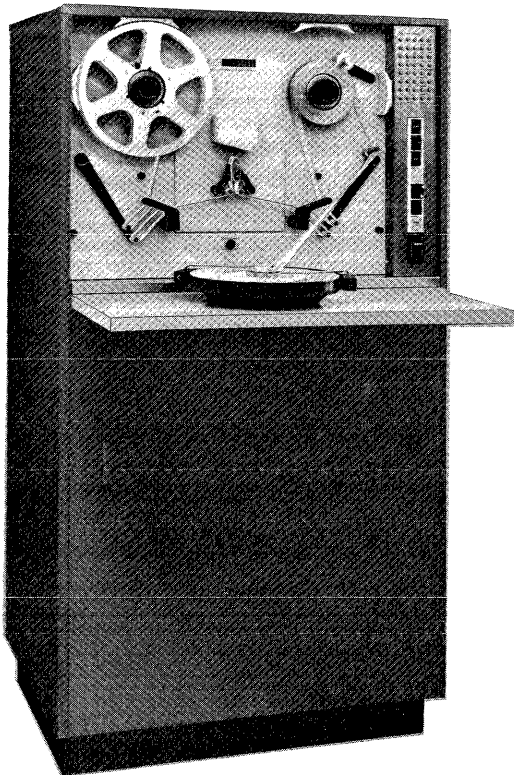

Figure 41. IBM 1011 Paper Tape Reader

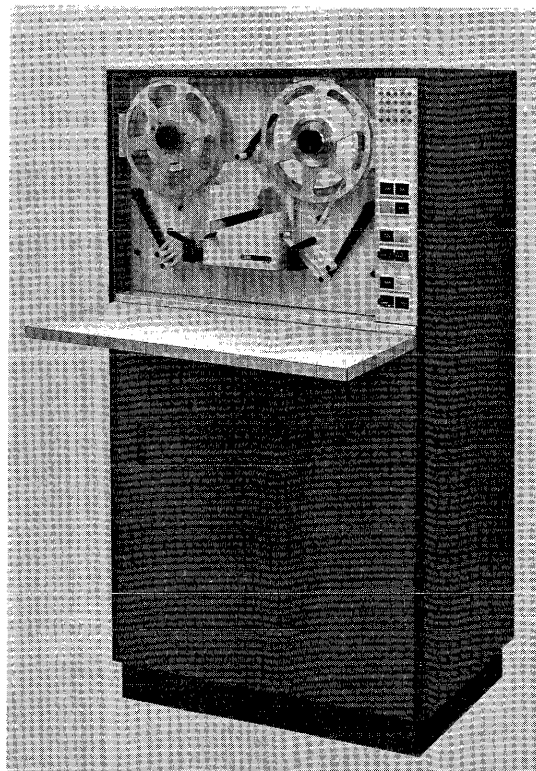

Figure 42. IBM 1012 Tape Punch

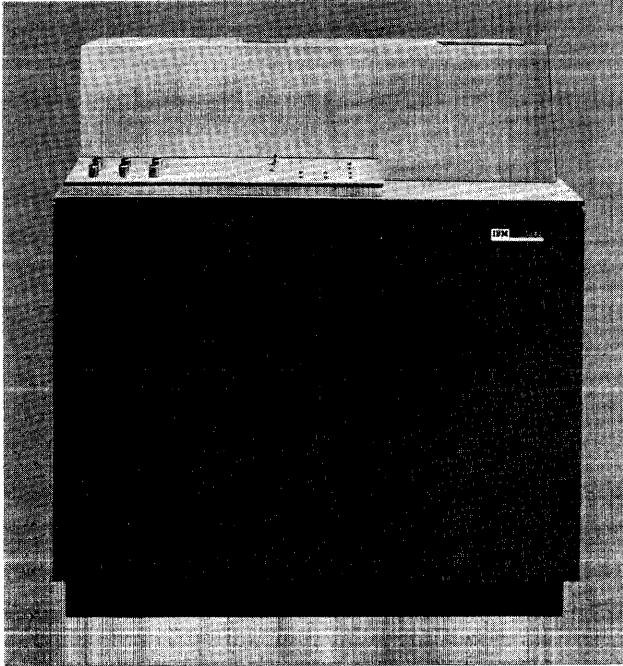

Figure 43. IBM 1231 Optical Mark Page Reader

IBM 1285 Optical Reader

The IBM 1285 Optical Reader (Figure 44) serves as an input unit for IBM 1401, 1440, 1460, and System/360 Model 30 and Model 40 Data Processing Systems. The 1285 reads printed paper tapes such as those produced on cash registers and adding machines. Using advanced optical-recognition techniques to read directly from the source document of many business transactions,



Figure 44. IBM 1285 Optical Reader

the 1285 eliminates the time, expense, and errors inherent in a system that requires information to be manually punched into cards before being entered into the system.

A keyboard also provides means for the operator to enter data into the system. The keyboard has two distinct functions:

1. Keying in header information before beginning to read a paper tape.
2. Keying in characters when on-line correction of rejected characters is performed.

Additional 1401, 1440, and 1460 machine instructions provide means of operating the IBM 1285 under control of a stored program. The ability to bring the flexibility of stored-program processing all the way to the source document means corresponding flexibility in the types of data that can be handled.

IBM 1412 and 1419 Magnetic Character Readers

When attached to a 1401 system, the IBM 1412 and IBM 1419 (Figure 45) permit fast and direct entry of banking transactions into core storage. Data, in the form of magnetically inscribed characters, is read from documents and transferred into core storage for processing. During this time, the documents are selected into stackers specified by the 1401 stored program.

IBM 1418 Optical Character Reader

Numeric data on printed card or paper documents can be read optically into 1401 core storage with the 1418 Optical Character Reader. Model 1, with three stackers, can select the documents according to class, or general category; Model 2 (Figure 46), with thirteen

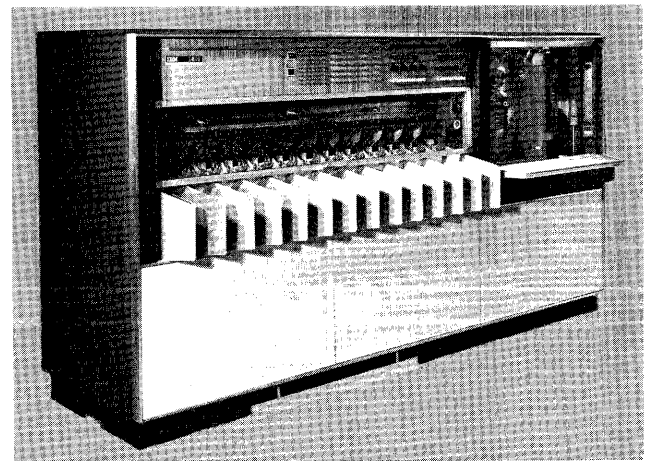

Figure 45. IBM 1419 Magnetic Character Reader

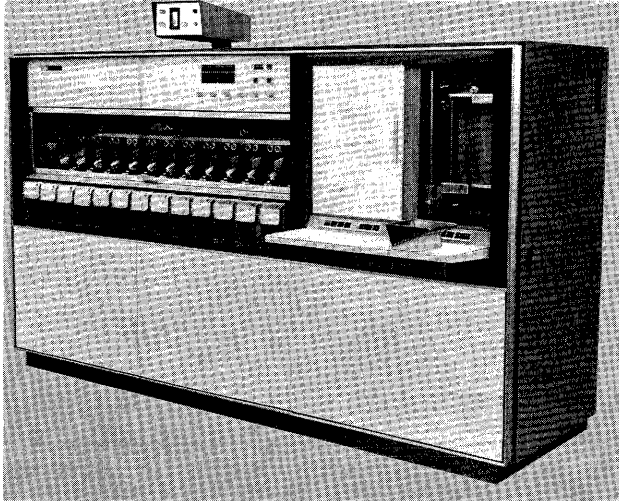

Figure 46. IBM 1418 Optical Character Reader

stackers, in addition to sorting by class, can sort each document numerically. Model 3, which is similar in appearance and operation to the Model 1, has a broader range of document-handling capabilities. The Model 3 is particularly adaptable to cash-accounting applications where a small stub is customarily returned with a payment.

In many instances, because of its ability to read characters directly from a document, the 1418 eliminates other preparation of data for use in the system. It allows all functions necessary for processing data, from the source document to the final report, to be performed in one operation.

IBM 1428 Alphameric Optical Reader

When connected to an IBM 1401 system, the IBM 1428 Alphameric Optical Reader (Figure 47) supplies high-speed alphabetic and numeric input to the data processing system from printed documents of various sizes. Thus, the 1428 provides for direct entry into the 1401 system of data from such documents as insurance premium notices, charge sales invoices, operations and route slips, payroll and dividend checks, and mail orders.

The IBM 1428, Model 1, is equipped with three sorter pockets. The Model 2 is equipped with thirteen pockets. The Model 3, which is similar to the Model 1 in appearance and operation, can handle documents of a broader size range. It is particularly adaptable to handling small stub-size documents such as those returned with a payment in many cash-accounting applications. The IBM 1428, Model 2, can also be used off-line as an optical sorter.

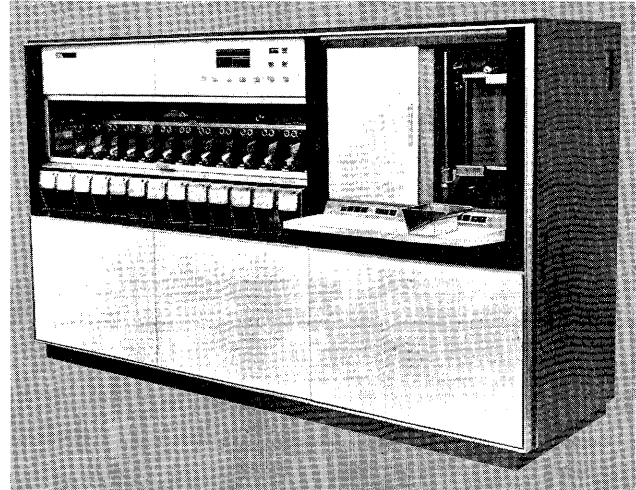

Figure 47. IBM 1428 Alphameric Optical Reader

IBM 1404 Printer

The IBM 1404 Printer (Figure 48) is another output medium for 1401 systems. It is a combination printer capable of processing either separate card documents or continuous forms. Under control of the 1401 stored program, and the tape-controlled carriage, this unique printer can process continuous forms at a rated speed of 600 lines per minute; or it can print on card documents at a maximum rate of 800 cards per minute. The 1404 can process cards ranging in size from 51 columns to 160 columns. It can also process two cards (51 to 80 columns) at a time. As many as 25 lines of data, either from 1401 core storage or from the card itself, can be printed on each card.

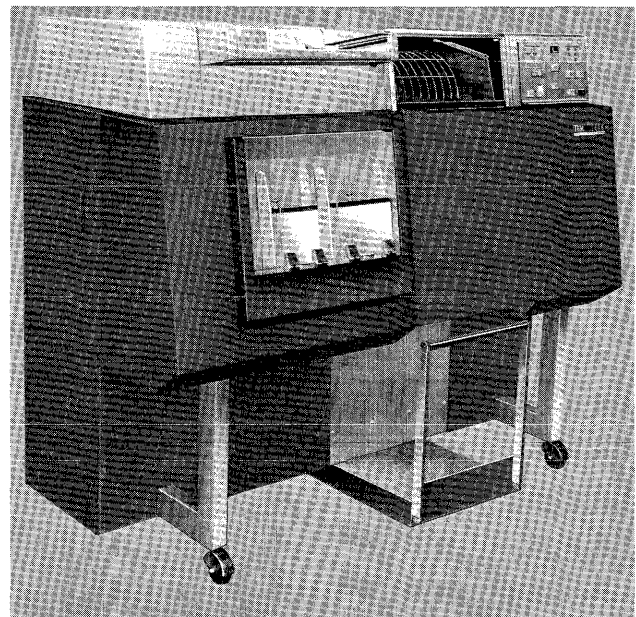

Figure 48. IBM 1404 Printer

IBM 1445 Printer

The IBM 1445 Printer (Figure 49) can print (in magnetic ink) both conventional characters and the E-13B type font approved by the American Banking Association. The standard typebar consists of 56 characters: 42 alphameric characters and 14 E-13B characters.

The maximum rated speed when using the 56-character bar is 190 lines per minute; however, two special feature character sets are available, 42-character bar (alphameric type) and 14-character bar (standard numeric type), to give rated maximum speeds of 240 and 525 lines per minute, respectively.

IBM 7340 Hypertape Drive Model 2

The IBM 7340 Hypertape Drive, Model 2 (Figure 50), when used with the IBM 1401 and 1460 Data Processing Systems, makes it possible to read and write magnetic tape at speeds of 34,000 alphameric characters a second, and 68,000 numeric characters a second. The speed of 68,000 numeric characters a second is possible by packing two consecutive digits on tape as one 8-bit character. (If the data is both alphameric and numeric, the speed ranges from 34,000 to 68,000 characters a second.)

As many as four hypertape drives can be connected to a 1401 or 1460 system through the IBM 7641 Hypertape Control and the serial I/O adapter feature. IBM 729 and 7330 Magnetic-Tape Units and 7340 Hypertape Drives, Model 2, can be connected to the same system for off-line conversion of existing tape libraries to hypertape for large-scale system use. Data is transmitted to and from the processing unit in 6- or 7-bit plus odd parity binary-coded decimal (BCD). The 7641

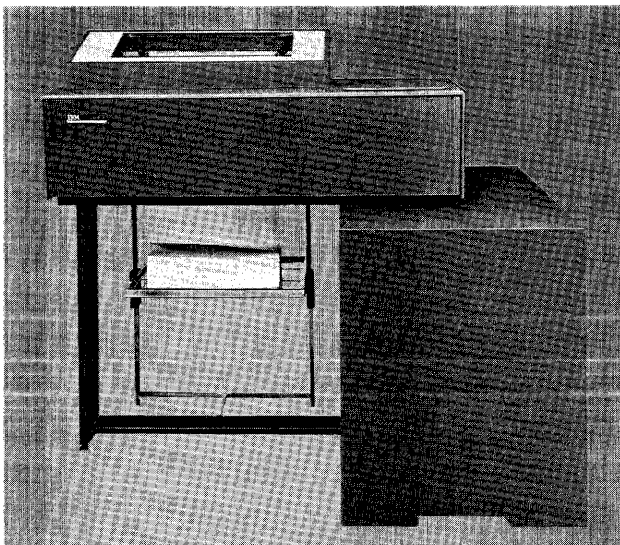

Figure 49. IBM 1445 Printer

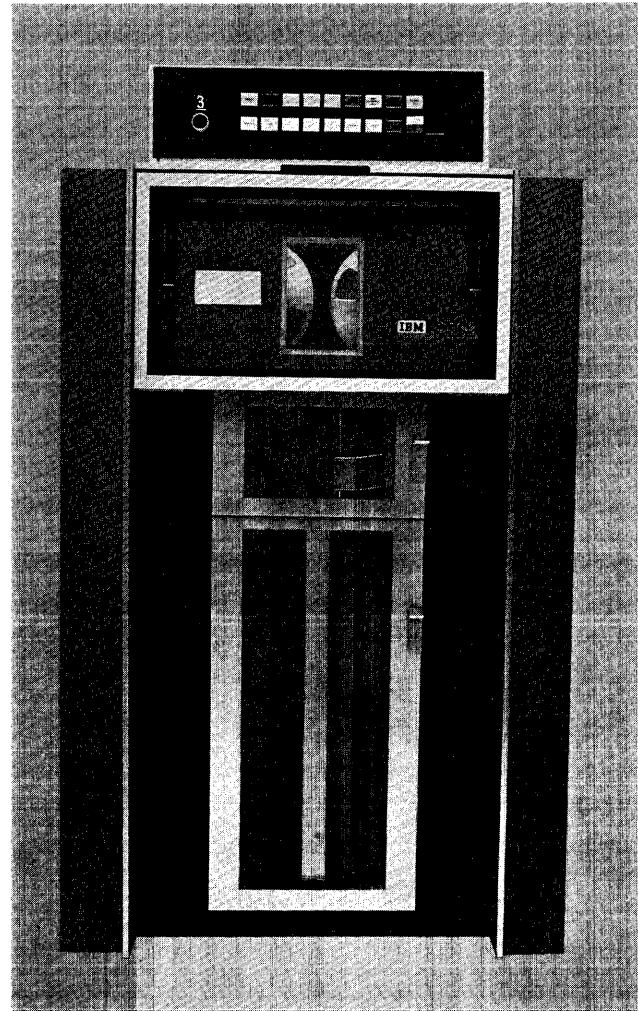

Figure 50. IBM 7340 Hypertape Drive Model 2

control unit contains a 6/8/6 converter, however, so tape can be written or read in the packed mode. Two check bits are provided on hypertape so all single-bit and most double-bit errors can be corrected.

The 1-inch-wide tape used with the hypertape drive is packaged in a tape cartridge. The tape cartridge eliminates manual threading and results in rapid loading and unloading. After the cartridge is inserted, the load operation is automatic and is accomplished in less than 15 seconds.

The dust resistant cartridge reduces contamination of the tape and prevents possible tape damage through handling. Also, the cartridge makes possible an unload operation without a rewind operation at any point in the file.

A highly reliable method of bit recording on hypertape is called IBM *phase encoding*. With this method, each bit (either a one or zero), is recorded by a 1-cycle wave form. The wave form used to write ones is posi-

tive and opposite in direction or phase to the negative wave form used to write zeros.

When tape is read, the sensing and decoding of a bit depends on the phase or direction of the recorded signal rather than on only the magnetic strength of the signal. Therefore, the possibility of losing a weak signal is lessened by using IBM phase encoding.

IBM 1401 Programs and Programming Systems

IBM provides 1401 users with programs and programming systems that relieve the user of excessive detailed programming effort. This section presents a *brief* description of each program supplied by IBM for 1401 systems. Publications supplying *detailed* information on each program are listed in the *IBM 1401 and 1460 Bibliography*, Form A24-1495.

Minimum Requirements

A summary chart (Figure 51) gives the minimum 1401 system requirements for the programs available from IBM.

Symbolic Programs

The IBM 1401 Data Processing System processes cards, tape, and disk records according to instructions given by the programmer. For the 1401 to execute a program, the instructions (operation codes) must be presented to the system in language the internal electronic circuitry can understand. This language is known as *actual machine language*.

However, writing a program in actual machine language creates problems in assigning data and instructions to storage locations. Using machine language also leads to difficulties when the program is written by a team of programmers, and it often results in programs that are difficult to correct and modify.

Therefore, IBM provides symbolic programming aids (languages and processors) which relieve the programmer of using actual operation codes and actual machine-language addresses.

The 1401 Autocoder programs are the basic symbolic-programming systems for IBM 1401 Data Processing Systems. Each consists of a set of language specifications for the programmer, and a processor program for the computer. The language is used to write the symbolic program, and the processor program translates the symbolic-language program (the source program) into the actual-machine-language program (the object program). The processor program not only translates but also determines how much storage is required, and it assumes the entire task of allocating storage locations to data and instructions. In other words, coding in actual machine language and developing the object program (program assembly) is done automatically. Hence, the name *Autocoder*.

The Autocoder language permits the programmer to

define areas, write instructions, and exercise some control over the execution of the processor program by writing symbolic statements. These statements are written using easily remembered (mnemonic) operation codes and symbolic names with which the programmer names data, instructions, and work areas. For example, a symbolic instruction to add the withholding tax in a field called WHTAX to the total deduction in a field called TOTDED would be written in symbolic language as WHTAX, TOTDED.

The programs and programming systems that IBM supplies for use on the IBM 1401 Data Processing System are discussed in the following sections.

SPS (Symbolic Programming System)

SPS is essentially a one-for-one coding system in which one symbolic statement is written for each instruction that appears in the object program. Two versions of the SPS are available. SPS-1 operates on a 1401 with a minimum of 1,400 positions of core storage, but it can assemble programs for any object-machine with as many as 4,000 positions of core storage. SPS-2 can assemble programs for any 1401 system (1,400 to 16,000 positions of core storage), but must assemble the program in a 1401 system with at least 4,000 positions of core storage.

An SPS source program must be coded on the 1401 Symbolic Programming System Coding Sheet. This coding sheet is designed for fixed-form coding. (A special area is reserved for each item to be contained in an SPS statement.)

Basic Autocoder 2K

Basic Autocoder 2K is a symbolic programming system designed to simplify the preparation of programs for IBM 1401 card systems with 2,000 core-storage positions. Basic Autocoder 2K is divided into two major categories: the symbolic language used by the programmer and the processor program.

The source program (written by the user) consists of statements written in symbolic language. These statements contain the information that the processor must have to assemble the object program.

The source program is the input to the processor program which is supplied by IBM. The output from the processor is the object program which is in machine-language form ready for execution.

Program Name	Positions of Core Storage	1402 Card Read-Punch	1403 or 1404 Printer	729 or 7330 Magnetic Tape Units	Number of Disk Storage Units:		Other Units	Special Features
					1311	1405		
SPS-1	1400	X	X					
SPS-2	4000	X	X					
Basic Autocoder 2K	2000	X	X					
Autocoder (on Tape)	4000	X	Model 2	4				Adv Prog, HLE, S Sw
Autocoder (on Disk)	4000	X	X		1			HLE
FORTTRAN	8000	X	X					Adv Prog, HLE, MD
Fortran IV	8000	X	X	4 (Note 2)	1 (Note 2)			Adv Prog, HLE
COBOL (on Tape)	4000	X	Model 2	4				Adv Prog, HLE, S Sw
COBOL (on Disk)	4000	X	X		1			Adv Prog, HLE
Input/Output Control System (on Tape)	4000	X	Model 2	4				Adv Prog, HLE, S Sw
Input/Output Control System (on IBM 1311)	4000	Model 1	Model 2					HLE
Communications Input/Output Control System (1026/DDC)	(Note 15)	X					1026 Connection only: 1-1026 1-1409 Model 2	Adv Prog, HLE, DDC (DDC Connection Only)
Communications Input/Output Control System (1448/7740/DDC)	4000	X					1-7740 (7740 connection only)	Adv Prog, HLE (7740 Connection only), DDC (DDC Connection only)
Basic 4K Report Program Generator	4000	X	X					
2K Report Program Generator	2000	X	X					
Report Program Generator (Card, 1405 Disk, Tape)	4000	X	X					
1401/1311 Report Program Generator	4000	X	Model 2		1			HLE
FARGO	4000	X	X					
Sort 1	4000	X	X	4				HLE
Sort 3	4000	X	Model 2	(Note 3)		1		HLE, S Sw
Sort 4	8000	X	Model 2	4				Adv Prog, HLE, S Sw Proc Ovlp
Sort 6	4000	X	Model 2		1			HLE
Sort 61	4000	X	Model 1		1			HLE
Sort 62	8000	X	Model 1		1			HLE
Sort 63	4000	X	Model 1		1			HLE, Dir Sk
Sort 64	8000	X	Model 1		1			HLE, Dir Sk
Sort 7	8000	X	Model 2	4				Adv Prog, HLE, S Sw
Merge 6	4000	Model 1	Model 2		1			HLE
Merge 7	8000	X	Model 2	3				Adv Prog, HLE, S Sw
Autotest	4000	X	Model 2	1 (Note 4)				Adv Prog, HLE, S Sw
Autotest 8K	8000	X	Model 2		1			Adv Prog, HLE
Autotest 16K	16000	X	Model 2		1			Adv Prog, HLE
Card System Utility Programs	1400	X	X					
Card System Subroutines	1400	X	X					
Card System Error Detection Aids	1400	X	X					
Tape System Utility Programs: Card-to-Tape	4000	X	X	1				HLE, S Sw—See Note 5

Figure 51. Minimum System Requirements (part 1 of 2)

Program Name	Positions of Core Storage	1402 Card Read-Punch	1403 or 1404 Printer	729 or 7330 Magnetic Tape Units	Number of Disk Storage Units:		Other Units	Special Features
					1311	1405		
Tape-to-Card	4000	X	Model 2	1				HLE, S Sw—See Note 5
Tape-to-Printer	4000	(Note 6)	Model 2	1				HLE—See Note 5
Multiple Utility Program	4000	X	Model 2	(Note 7)				Adv Prog, HLE, RP Rel, S Sw—See Note 5
Multiple Utility Program with 120-Character Label Capability	8000	X	X	(Note 7)				Adv Prog, HLE RP Rel, S Sw—See Note 5
Tape Reading and Writing Subroutines: Tape Read; Tape Write	4000			1				
Tape Read/Write	4000			1				Adv Prog
1012 Tape Punch Routines	4000	X	Model 2	4				Adv Prog, HLE, S Sw
Disk Utility Programs (1311)	4000 (Note 8)	X	X	(Note 3)	1			
Disk Utility Programs (1405)	4000	X	X	(Note 3)		1		
File Organization Programs (1311)	4000	X	Model 2		1			See Note 9
File Organization Programs (1405)	4000	X	X			1		
Data Communications Utility Programs for IBM 1009	4000	X	Model 2	(Note 10)	(Note 10)		1 — 1009	HLE
1401/1009 Utility Program	4000	(Note 11)		(Note 11)			1 — 1009 1 — remote terminal (Note 12)	S Sw, Ser I/O Ad
1401/7710 Utility Programs: Tape Transmit; Tape Receive	4000	X		1			1 — 7710 1 — remote terminal (Note 13)	Ser I/O Ad
Transmit/Receive	4000	X		1			1 — 7710 1 — remote terminal (Note 13)	Adv Prog, S Sw, Ser I/O Ad
7750 Assembly Program Using the IBM 1401	4000	X	Model 2	3				Adv Prog, HLE
1401 Peripheral Integrated Processing System for Use with IBM 7000 Series Data Processing Systems	4000	X	X	3				Adv Prog, HLE, Pr Stor, Exp Pr Ed
1401 I/O Control Program for Use with the IBM 7040/7044	4000	X	X				(Note 14)	Adv Prog, Col Bin, HLE, Ser I/O Ad
Abbreviations: Adv Prog — Advanced Programming Col Bin — Column Binary DDC — Direct Data Channel Dir Sk — Direct Seek Exp Pr Ed — Expanded Print Edit HLE — High-Low-Equal Compare MD — Multiply-Divide Pr Stor — Print Storage Proc Ovlp — Processing Overlap RP Rel — Read Punch Release S Sw — Sense Switches Ser I/O Ad — Serial I/O Adapter								
Note 2: Either four tape units or one IBM 1311 is required for assembly. Note 3: One tape unit is required for tape input or tape output. Note 4: Two tape units are required if the RAMAC file trace or snapshot portions of the program are used. Note 5: Column binary feature is also required if binary tape records or column-binary cards are to be processed. Note 6: When this program is included by the user on a system tape, the 1402 is not required; otherwise, the 1402 is required. Note 7: At least one tape unit is required for each tape operation to be performed concurrently. Note 8: If track-record format is used, 8000 positions of core storage are required. Note 9: Control-sequential routines require the HLE special feature. Note 10: One tape unit is required if either tape-transmit or tape-receive is used, and one IBM 1311 is required if either disk-transmit or disk-receive is used. Note 11: Either a 1402 or one tape unit can be used. Note 12: The remote terminal can be one of these: IBM 1401-1009, IBM 1410-1009, or IBM 7701. Note 13: The remote terminal can be one of these: IBM 1401-7710, IBM 1401-1009, IBM 7701, IBM 7702, or IBM 1013 Note 14: The IBM 7040/7044 must include a 1401 Adapter attached to the IBM 7106/7107. Note 15: The core storage required depends on the options taken and whether DDC is used.								

Figure 51. Minimum System Requirements (part 2 of 2)

The processor program analyzes the information it receives when the source program statements are fed into the machine. As each statement is analyzed, the processor program assembles the machine-language instruction, or constant, and punches it into another card, in one-instruction-per-card format. The punched output cards also include the loader.

The user can further process the one-instruction-per-card object program deck, to convert it into a multi-instruction-per-card deck. This converted deck is called the *condensed* deck. The Basic Autocoder 2K processor contains a condensing routine that can be used for this purpose.

Autocoder (on Tape)

IBM 1401 and 1460 Autocoder (on tape) is a more flexible symbolic programming system than Basic Autocoder 2K for the IBM 1401 Data Processing System. This Autocoder programming system for the IBM 1401 is called *Autocoder (on Tape)* because the processor program resides on and operates from magnetic tape units.

The Autocoder processor program supplied by IBM produces machine-language object programs from source programs written by the user in the symbolic language of Autocoder.

Autocoder also provides a powerful facility that permits the user to write in his source program a single symbolic instruction (macro) that will cause an entire routine to be developed. A macro instruction causes the automatic insertion of a series of machine-language instructions in the object program. Autocoder processes macro instructions provided in the Autocoder library (a collection of standard routines), in addition to any included by the user. This relieves the programmer of much repetitive coding.

Autocoder (on Disk)

The IBM 1401, 1440, and 1460 Autocoder (on disk) is an advanced programming system that consists of a system-control program and an Autocoder assembler program. An IBM 1401 Data Processing system with an IBM 1311 can use the programming system to translate source-program statements, written in the Autocoder language, into machine-language instructions. In addition to this translating function, the Autocoder system also provides these additional features:

Relocating the Autocoder Library. The user is provided with expansion capabilities of the Autocoder library previously not available with an Autocoder processor. Furthermore, should the user wish, he can relocate the Autocoder library to an area of his choice in disk storage.

Building Multiple Autocoder Libraries. In addition to being able to relocate the Autocoder library, the user also can build more than one Autocoder library. Small libraries, that contain selected routines appropriate to particular types of job processing, can significantly reduce program-assembly time.

Changing Input/Output Devices. The Autocoder system provides the capability of changing input/output devices and/or areas that are used by the Autocoder system for particular jobs. The user can change these devices or areas according to his particular needs. For example, he can change his input from cards to disk.

Stacking of Jobs. Autocoder (on disk) enables the user to process a series of jobs without regard to the type of processing that is being performed. For example, the user may assemble source-program number one, partially assemble source-program number two, and execute object-program number three, all in one stack (a stack is a set of one or more jobs).

Building an Object-Program Library in Disk Storage.

This feature enables the user to build an object-program library in disk storage. The upper and lower limits of each object program stored in this area of disk storage are supplied to the user by the Autocoder system. Thus, the user has immediate access to any one of the object programs stored therein. Using an object-program library substantially reduces program-loading time (as opposed to loading from cards), and reduces handling of punched-card decks containing the object program.

Executing Punched-Card Object Programs. If a program is infrequently used, the user may wish to maintain a punched-card object program and save disk storage for other purposes. When this is the case, the user is afforded two options for executing this object program. He can execute the object program under control of the Autocoder system (as a job in a stack of jobs), or he can execute the object program independently from the system.

Fortran

The IBM 1401 Fortran is a symbolic programming system composed of a language and a processor program (compiler). Symbolic or source statements are coded using the 1401 Fortran language, which closely resembles the language of mathematics. The *source program* is a particular sequence of source statements. After being coded on the Fortran Coding Form, the source statements are punched into cards, which are then used as input to the 1401 Fortran compiler. The compiler

translates the source program to a 1401 machine-language program (*object program*) that can be executed immediately or punched into cards for future use.

Fortran IV

The Fortran IV processor program is a language processing system that operates entirely under control of a system-control program. Together, the Fortran IV processor program and the system-control program make up the Fortran IV system.

The Fortran IV system translates source program statements written in the Fortran language into machine-language instructions. In addition to this translating function, the Fortran system provides these additional features.

Expanding the Fortran Library. A Fortran library is defined by the system that contains commonly used subroutines and functions, such as sine, cosine, and logarithms. The Fortran IV system provides the capability of expanding the library to include additional user-supplied subroutines. Also, if the system is disk-oriented, the user can relocate the library to an area of his choice in disk storage.

Changing Input/Output Devices. The Fortran IV system provides the user with the option of changing the form of input to and output from specific jobs. In order for the Fortran IV system to operate at a machine-independent level, a set of logical files that are used for input/output operations has been defined. Although these logical files are assumed by the system-control program to be assigned to a defined set of input/output devices, the user can change these assignments according to his particular needs.

Stacking of Jobs. Source programs can be compiled and object programs can be executed, all in one stack, without regard to the type of processing that is being performed.

Building Object-Program Libraries in Mass Storage.

By using a particular logical file (SYSTEM) defined by the Fortran system, it is possible to build an object-program library in mass storage (disk storage or magnetic tape).

Cobol (on Tape)

The name *Cobol* is derived from the words *Common Business Oriented Language*. The Cobol language is similar to English and designed primarily for commercial data processing.

The programmer uses the characters, words, and expressions that make up the Cobol language to write the source program, which is punched into cards and used as input to the Cobol processor.

The Cobol processor is itself a program. This program resides on and operates from magnetic tape. The processor translates Cobol statements from the source program into 1401 Autocoder language statements, which are then assembled into 1401 machine language by the Autocoder processor.

Cobol (on Disk)

The similarity between Cobol and ordinary business English provides programmers with a convenient method for writing source programs. Source-program statements are translated into machine language by the Cobol system, permitting the programmer to direct his attention primarily toward the solution of the problem, rather than toward the specific method of implementing the solution on the machine.

This system resides on a file-protected area of a disk-storage unit. By the use of a system-control program, the controlling element of the Cobol system, it is possible to stack the input to and output from a series of tasks. Further, the system-control program allows the user to assign input/output devices for a defined set of logical files.

Input/Output Control System (on IBM 1311)

Input/Output Control System (IOCS) for the IBM 1401 is not a complete program in itself, but rather is a set of library routines that supplement the 1401 Autocoder program designed for use with a 1311. It handles input/output operations, including reading and writing, blocking and deblocking, label handling, and error checking.

From the library, the specific routines that are required for a particular program are selected and included with the user's program at assembly time. The macro-generator phase of the Autocoder program makes this selection based on the DIOCS and DTF entries and on the IOCS macro instructions that are part of the user's source program.

Input/Output Control System (on Tape)

The IBM 1401 IOCS eliminates the need for detailed programming of standardized input and output routines. IOCS requires descriptive entries and macro instructions in addition to those used by the Autocoder program. With these, the user has access to routines for reading and writing, blocking and deblocking, file labeling, and error checking.

IOCS library routines are selected and tailored automatically by the Autocoder processor to satisfy the particular requirements of each job. Autocoder generates the minimum number of instructions needed according to the detailed information the user supplies in the descriptive entries.

Although primarily concerned with magnetic-tape files, IOCS also applies to unit-record files in the IBM 1402 Card Read-Punch and to continuous forms prepared by the IBM 1403 and 1404 Printers.

Communications Input/Output Control System (1026-DDC)

This system relieves the programmer of much programming effort required to control data transmission to, and from, remote terminals connected to an IBM 1026 Transmission Control Unit.

This program serves the user in several ways. It provides routines to handle programming functions such as priority-request, end-of-block detection, error-detection, and output-scheduling. It schedules entry into user routines, and defines what programming functions can be performed within user routines associated with the IBM 1026. The system is assembled on an option basis so that the user's descriptive entries determine the presence of routines and reserved core-storage areas.

The direct-data-channel for communications IOCS (1026-DDC) permits direct transfer of data between two systems. Concise and efficient routines handle these functions:

- Program detection of READ REQUEST or WRITE REQUEST by either system.
- Priority (interrupt request).
- Error-detection and correction.
- System-to-system read/write.
- Output scheduling.
- Coordination with other IOCS programs.
- Scheduling of the user's DDC (direct-data channel) routine for each system.

Communications Input/Output Control System (1448-7740-DDC)

Communications IOCS (1448-7740-DDC) provides routines that free programmers using a Tele-processing system from most of the coding required to transfer data between an IBM 1401 system and an IBM 7740 Communication Control System. The user must supply the specifications for the program related to the particular job to be performed by the IBM 1401.

Direct transfer of data between a 1401 system and a 1440, 1460, or another 1401 system can be accomplished by using the direct-data-channel special feature. Applications of such direct-data transfer include:

1. multi-processing of data
2. internal processing on one system, and peripheral operations on the other system
3. processing data from multiple remote terminals.

Communications IOCS (1448-7740-DDC) provides routines to perform these functions:

- reading and writing data messages
- reading and interpreting control messages
- writing sense data and service messages
- priority request
- error detection
- output scheduling
- coordination with other IOCS programs
- scheduling the user's routine for processing
- records received from the 1410 or 7010 system.

Basic 4K Report Program Generator

The Basic 4K Report Program Generator (BRPG) for IBM 1401 and 1460, with load-and-go capability, produces programs that write reports of variable format from card input files. Instead of writing a specific program for each report, the user writes a set of specifications and prepares one control card. He supplies these to the BRPG. BRPG then generates the object program.

The user has the option of specifying that BRPG punch the machine-language object program in cards. This option enables him not only to execute the program from core storage, but furthermore to retain the object-program deck for future use.

Together with the generated object program, BRPG also provides the user with an *edit listing*. This is a printed record of the source program and an analysis of the specifications cards. Certain kinds of errors, such as unacceptable entries in the report specifications, produce error messages.

Programs generated by BRPG can produce output in any of these forms:

- Printed report.
- Punched cards.
- Printed report and punched cards.

2K Report Program Generator

The 2K Report Program Generator (2K RPG) is designed for use on an IBM 1401 card system with 2,000 positions of core storage. The 2K RPG is similar in purpose to the Basic RPG. The user states his problem and solution (the report specifications) in 2K RPG language. The 2K RPG processes the specifications and generates a program to write the report. By relieving the user of most of the machine coding, 2K RPG permits him to concentrate his efforts on the best solution to his problem.

Programs produced by 2K RPG write reports in varying formats, using the source data contained in the user's card files. Output from programs produced by 2K RPG can be punched cards and/or a printed report.

Report Program Generator (RPG)

The Report Program Generator is a special program designed to create report-writing object programs from report specifications given by the user.

Instead of writing a specific program for a report, the user states his problem in RPG language. The RPG processor program interprets these specifications and generates an object program that uses source data from punched-card, magnetic-tape, or 1405 disk-storage files. Output from the RPG-produced programs can be printed reports, punched cards, or magnetic tape.

The reports produced by programs generated by the RPG range from a simple listing of items from the input file to complex reports that incorporate editing and calculating the input data. Included are such functions as printing various kinds of lines (heading lines, detail lines, total lines initiated by control-field changes, and offset total lines); crossfooting; and summary punching. Exception records can be produced with the reports.

Report Program Generator for IBM 1401-1311

The Report Program Generator for IBM 1401-1311 systems creates report programs with a minimum of time and effort. The user writes a set of specifications stating the characteristics of the input data from which the report is to be made and the characteristics of the desired report. These specifications are punched into cards, which become input to the Report Program Generator. The specifications are processed and a report program in symbolic language is generated. This symbolic program becomes input to the IBM 1401-1311 Autocoder processor, which produces the report program in machine language. The machine-language program, when supplied with input data and executed, produces the output report in any combination of three forms: printed, punched card, and either magnetic tape or 1311 disk storage.

The input file from which the data for the report is taken may consist of data records that are contained in punched cards, on magnetic tape, or in 1311 disk storage.

Fargo (Fourteen-O-One Report Generating Operation)

Fargo is a special program, consisting of four distinct phases, designed to produce printed reports according to user specifications.

The user codes specifications for each phase in one of four Fargo formats. (There are four different Fargo coding sheets, one for each phase of the Fargo program.) The Fargo program uses these specifications to modify itself and perform the necessary operations in producing a printed report from data following the Fargo program and specifications.

Fargo is specifically designed for card-oriented systems.

Sort 1

Sort 1 is a generalized, 2-way-merge sorting program for IBM 1401 systems with a minimum of 4,000 core-storage positions and four magnetic tape units. It is considered a *generalized* sort program because it is capable of modifying itself according to specifications provided by the user in control cards.

Sort 1 can sort fixed-length magnetic-tape records (either single or blocked) into an ordered sequence of records. The control data of each record can be located in more than one place in the record and can be of different sizes for different files. The input records can be in any order. They can be contained on from one to 99 reels; however, there must be no more input records than will fit on one output reel.

The Sort 1 program consists of two phases. Phase 1 reads into core storage a number of input records, sorts them internally, and writes the short sequences on alternate output tapes. Phase 2 performs a 2-way merge, using four tape units: two for input and two for output. The last pass of phase 2 writes the entire sorted file on one tape reel. A fifth tape unit, if available, can be used to store unreadable records and records larger or smaller in length than specified in the control cards. If a fifth tape is not provided, this information is punched into cards.

Sort 3

Sort 3 is a generalized sorting program that uses the IBM 1405 Disk Storage to sort records from a magnetic-tape or disk-storage input file. Sorted output, in either ascending or descending sequence, is written either on magnetic tape or in IBM 1405 disk storage. Input records must be fixed length, blocked or unblocked.

Sort 4

Sort 4 is a generalized tape sorting program for an IBM 1401 system equipped with the processing-overlap special feature. The program sorts fixed- or variable-length, blocked or unblocked, magnetic-tape records into ascending or descending sequence. Sort 4 provides automatic label-checking operations for IBM 1401 standard header and trailer labels. Exits are provided to permit the user to insert routines that check non-standard header and trailer labels.

Sort 6

Sort 6 consists of a set of generalized sorting routines. They are incorporated in the 1401-1311 Autocoder system library. The user supplies to the 1401-1311 Autocoder processor a description of the kind of sort pro-

gram that he wants. The Autocoder then generates a sort program conforming to his general specifications.

This program is a generalized one that can be used for many sorting applications. Prior to each sorting run, the user must modify the generalized program (by using the appropriate control cards) to suit his particular input file and to specify certain processing options. Sort 6 provides automatic input and output label-checking options. The program operates on IBM 1401 systems equipped with an IBM 1311 Disk Storage Drive.

Sort 6 can sort blocked or unblocked fixed-length data records contained in cards, on magnetic tape, or in disk storage. The sorted output can be written on magnetic tape or in disk storage, in either ascending or descending sequence.

Sorts 61, 62, 63, and 64

Sorts 61, 62, 63, and 64 are IBM-supplied object programs that have been generated by the Sort 6 program. Each of these programs is a generalized object program requiring control cards. Sorts 61 and 62 read and write disk using normal-seek operations; Sorts 63 and 64 read and write disk using direct-seek operations.

Sorts 61 and 63 are designed for use on systems with at least 4,000 positions of core storage. Sorts 62 and 64 are designed for use on systems with at least 8,000 positions.

Sort 7 and Merge 7

Sort 7 and Merge 7 are generalized programs that sort and merge magnetic-tape files. The programs provide automatic label-checking operations for IBM 1401 standard header and trailer labels. Exits permit the user to insert his own label-checking routines for non-standard header and trailer labels.

Sort 7 can sort tape records into either ascending or descending sequence. It sorts fixed-length or variable-length records that are blocked or unblocked. The last phase of Sort 7 produces a single sequential file.

Merge 7, a single-pass program, can combine as many as five tape files into a single sequential tape file. It can also sequence-check or reblock a single tape file.

Sort 7 and Merge 7, although they are separate programs, can be used to complement each other. Thus, each reel of a file can be sorted by Sort 7, and the resulting sorted reels can be merged by Merge 7.

Merge 6

Merge 6 for the IBM 1401 Data Processing System provides the user with the ability to combine previously sorted files into one continuous file. The collating sequence (either ascending or descending) that was used

to sort the original files must also be used in the merge operation.

Merge 6 is a generative program designed for incorporation into the IBM 1401-1311 Autocoder library. By selecting the parameter cards that define his particular merging application, the user can produce his desired object program with Autocoder and the macro generator. The parameter cards determine the contents of the generated object program.

When generated, the object program is a general program. It can be tailored to the user's specific needs, however, by inserting control cards.

Autotest

Autotest is a testing program for the IBM 1401 Data Processing System. It effectively uses the power of the 1401 system to aid in the testing of Autocoder, SPS, and Fargo programs. Autotest provides the ability to stack programs and produce documentation to evaluate the tested programs. Coupled with the ability to generate operating instructions and automatically print core storage and tapes, the Autotest program provides the following features that may be selected by the user:

1. Tape File Generator
2. RAMAC File Generator
3. Automatic Patching—The ability to correct the object program automatically without reassembling or manually calculating patching addresses.
4. RAMAC File Trace—Data read or written in the disk file during the execution of the object program will be traced and printed.
5. Snapshot core prints may be obtained during the execution of the object program.
6. An 80/80 listing, identified by program, may be obtained for all punched output.

These features of the Autotest program may be used in any desired combination as tools for obtaining efficient and successful testing of 1401 programs. The program can handle only program input from cards and cannot be run on the 1410.

Autotest (8K and 16K)

Autotest, a testing program for the IBM 1401 and 1460 Data Processing Systems, controls the use of utility programs to provide complete documentation for program evaluation. It is useful for remote testing because it provides the programmer with an opportunity to pre-plan his test run with a minimum of operator intervention.

There are two versions of the Autotest program available to the user, 8K and 16K, depending on the minimum size of the object machine used. Both versions perform exactly the same functions and are designed so

the core-storage area occupied by Autotest during the running of the object program occurs in the upper core-storage positions of the object machine (8K or 16K) used. With the exception of some core-storage considerations, the specifications and operating procedures for the two versions of Autotest are identical.

The Autotest program:

- Clears core storage before loading each object program.
- Loads the object program.
- Executes the object program.

Also, Autotest provides the following program features, which may be selected by the user.

1. Clear Disk Storage—Selected areas of disk storage can be cleared before or after execution of the object program.
2. Disk Record Load—Provides for the creation of disk records from card input prior to the test of each individual program.
3. Print Disk—Data from selected areas of disk storage can be printed before or after execution of the object program.
4. Disk-Label Program—Performs all necessary maintenance operations on the label track of a disk pack.
5. Tape-File Generator—Provides for the creation of tape files prior to the test of each individual program.
6. Tape-to-Printer—Prints fixed- or variable-length, blocked or unblocked tape records.
7. Snapshot—Data from a selected area of core storage can be printed at specified times during the execution of the object program.
8. Disk Trace—Data that is read from, or written on, the disk during execution of the object program is traced and printed with the control field of the read or write instruction.
9. Core-Storage Printout—The contents of core storage can be printed at the end-of-job or when a *hang-up* condition occurs.
10. Autopatch—Allows the programmer to correct the object program without reassembling or computing 3-position machine addresses. Patch instructions can have indexed operands.
11. 80/80 List—An 80/80 list of all punched-card input and output can be obtained at the end of the complete test session.

Any number of these optional features can be used when testing an object program.

The IBM 1401-1311 Autotest program requires that the assembled program be in the same format as the condensed Autocoder card output.

Card System Programs

IBM provides a number of utility programs, subroutines, and program error-detection aids for users of IBM 1401 card systems. They are:

Utility Programs

Clear Storage. This program clears all storage positions to blanks and sets a word mark in location 001.

Card Loader. This program enables the user to load instructions and constants into the machine prior to loading and running a program. The instructions and constants must be in machine language and must be punched with one instruction or constant per card.

Print Storage. This program enables the user to print out the contents of selected portions of core storage, as specified in a control card.

Punch Storage. This program enables the user to punch the contents of selected portions of storage into cards. The resulting card output is in the form of a self-loading deck that can be loaded into storage by the card-loader utility program.

Punch-List-Sequence Check. This program punches, prints, or sequence-checks information from an input program deck, the format of which conforms to that specified for the card-loader program. Any combination of these three operations can be performed simultaneously by the punch-list-sequence-check program.

Subroutines

Multiply I. This subroutine multiplies two numbers, each having a maximum of ten digits. A maximum of twenty digits and a sign can be obtained as a product. The important feature of this subroutine is its use of a minimum of storage space.

Multiply II. This subroutine multiplies two numbers, each having a maximum of nine digits. A maximum of 18 digits and a sign can be obtained as a product. The important feature of this subroutine is economy in time, whereas multiply I features economy in storage space.

Divide. This subroutine uses repetitive subtraction to perform division. The length of the divisor, dividend, and quotient may range from 1 to 20 digits.

Dozen-to-Units Conversion. This subroutine converts dozens, and fractions of dozens, to units.

Units-to-Dozens Conversion. This subroutine converts units to dozens and fractions of dozens.

Program Error—Detection Aids

Insert Halts. This program inserts halt instructions in an object program at specified places to permit manual inspection of the contents of core storage.

Insert Linkages to Fixed Print Storage. This program inserts into desired sections of an object program linkages to a routine that prints out the contents of storage between specified limits. This print area can be specified only once for the object program.

Insert Linkages to Selective Print Storage. This program performs the same function as the preceding program, except that the limits of storage to be printed can be varied for a single object program.

Remove Linkages. This program removes from an object program those linkages previously inserted to aid in detecting program errors.

Tape System Utility Programs

The five utility programs for IBM 1401 tape systems perform functions otherwise handled by off-line IBM card-to-tape, tape-to-card, and tape-to-printer equipment. The tape utility programs perform additional functions that cannot be performed by auxiliary or off-line equipment.

Card-to-Tape

This program prepares single tape records from single card records in either the BCD or column-binary mode. It also has the following capabilities, unavailable in auxiliary or off-line equipment: input records can consist of more than one card; output records can be blocked on tape; variable-length input fields can be selected for output on tape; an exception procedure enables certain input records to be treated differently from the usual routine; input records and cards within input records can be sequence-checked prior to output.

Tape-to-Card

With this program the user can prepare card records in either the BCD or column-binary mode from single tape records. The program also has the following capabilities, unavailable in auxiliary or off-line equipment: input tape records can be blocked; variable-length tape records can be accommodated; output records can consist of more than one card; input fields can be selected for output in specified card fields; an exception procedure

enables certain input records to be bypassed, printed, stacker-selected, or printed and punched; input records can be sequence-checked prior to output.

Tape-to-Printer

This program prints single or blocked variable-length input records. It also has the following capabilities, unavailable in auxiliary or off-line equipment: multiple-file printing and selective-file printing; input fields can be selected for printing and can have editing and zero suppression; an exception procedure enables input records to be bypassed or treated in a manner differing from ordinary routine; various types of forms-control spacing can be specified; input records can be sequence-checked prior to printing.

Multiple Utility Program

This program permits any one, two, or all three of the tape utility programs (card-to-tape, tape-to-card, and tape-to-printer) to be executed concurrently. Operation of this program is under sense-switch control. Some of the additional features of the individual tape utility programs are not available in this combined-operation program.

Multiple Utility Program with 120-Character Label Capability

This multiple tape utility program performs any combination of the following three tape operations in one operation: card-to-tape, tape-to-card, and tape-to-printer operations. In each case, the program can read or write (as the case indicates) unlabeled tape files or tape files with standard 120-character tape labels.

Tape Reading and Writing Subroutines

Three individual programs are provided: read, write, and read/write. They are distributed in symbolic (SPS) form to facilitate incorporation into any program written in SPS or Autocoder language. Standard error-checking and record-recovery procedures are used in the programs.

IBM 1012 Tape Punch Routines

These routines relieve the user of detailed instruction coding for these IBM 1012 functions pertaining to 5- or 8-track tape: tape punching, error checking, automatic error correction, end-of-record processing, and end-of-reel processing. The routines, as written, are to be incorporated in the Autocoder system library and can be inserted in any program assembled by Autocoder. Two macro instructions (PTAPE and CTAPE), when used in the symbolic source program, cause the 1401 Autocoder or the 1401-1311 Autocoder processor to insert the appropriate routines in the user's object program.

Disk Utility Programs (IBM 1311)

Nine disk utility programs assist users of the IBM 1401 equipped with IBM 1311 disk storage in the operation of their installations. By means of these programs, certain frequently required operations (such as loading or unloading disk files from cards, and printing out areas of disk storage for program-testing purposes) can be performed without programming effort on the part of the user. Each program includes a label-checking routine. A brief description of each program follows.

Disk Label Program

This program can write the label track, delete the label track and restore the normal sector addresses, enter labels, delete labels, change specified fields within labels, print labels, and punch labels in the RDLIN-card format. The RDLIN card contains the label information in the format required by the label-checking routines of IBM 1401 programs that process IBM 1311 disk files.

Clear Disk Storage

This program clears specified portions of disk packs by filling these areas with blanks or any other valid 1401 character. It can write sequential addresses referenced to any disk drive, or write the same addresses that were on the pack.

Disk-to-Tape

This program writes the contents of specified areas of disk storage on magnetic tape in the format used by the tape-to-disk program.

Tape-to-Disk

With this program the user can reload areas of disk storage previously written on magnetic tape by the disk-to-tape program. He can reload all of the data or selected portions of it.

Disk-to-Card

This program punches the contents of specified areas of disk storage into cards in the format used by the card-to-disk program.

Card-to-Disk

This program reloads into disk storage the data that was punched into cards by the disk-to-card program.

Copy Disk

This program can write data and addresses from specified areas of a disk pack either to another pack located

on a second drive, or to another area of the same pack. When copying onto a second pack, the program can write the information either in the same position on the second pack relative to that of the source pack, or in a different relative position. In all cases when the information is written in a different relative position, disk addresses (if written) are adjusted to be valid for the new location.

Print Disk

This program prints the contents of specified areas of disk storage on the IBM 1403 Printer.

Disk-Record-Load

Addresses, single records, parts of records, or entire tracks can be loaded into disk storage from cards, by using this program.

Disk Utility Programs (IBM 1405)

Utility programs for IBM 1401 systems equipped with IBM 1405 disk storage are available. They facilitate the transcription of data between disk storage and magnetic tape, and between disk storage and punched cards. Another utility program is provided to clear disk storage.

Clear Disk Storage

This program clears the contents of disk storage to blanks. The portion or portions of the IBM 1405 disk storage to be cleared can be specified by the user in one or more control cards. A minimum of one track (10 sectors) and a maximum of 10,000 tracks can be cleared with this program.

Disk-to-Tape

With this program the user can write the contents of specified areas of disk storage on magnetic tape. Provisions are made in this program for the user to subsequently reload the information into the disk locations from which it was unloaded. The tape-to-disk program is provided for this purpose.

Disk-to-Card

This program punches into cards the contents of specified areas of disk storage. The data thus punched can be reloaded into the disk locations from which it was unloaded. The card-to-disk program is provided for this purpose.

Tape-to-Disk

The primary use of this program is to reload into disk storage data that was previously unloaded onto magnetic tape (see *Disk-to-Tape*). The program can also be used to write records from tape into disk storage (even though they were not previously stored on disks), provided that the tape records are in the same format as that produced by the disk-to-tape program.

Card-to-Disk

The primary use of this program is to reload into disk storage data that was previously unloaded into punched cards (see *Disk-to-Card*). The program can also be used to write records from punched cards into disk storage (even though they were not previously stored on disks), provided that the card records are in the same format as that produced by the disk-to-card program.

Disk-to-Printer

This program can print on the IBM 1403 Printer the contents of specified areas of disk storage.

File Organization Programs (IBM 1311)

Two sets of disk file organization programs are provided to aid users in establishing and maintaining their data files in IBM 1311 disk storage. These programs are of the *generative* type. That is, the user supplies a set of parameters for his particular application. From these parameters, the IBM 1401-1311 Autocoder program, using the file-organization routines, generates a file-organization *object* program that is appropriate for the application.

One set of file-organization routines is designed for random files, and the other, for control-sequential files.

Random Programs

These programs are:

- Two-pass load program for master records
- Additions program for master records
- Loading and additions program for trailer records
- Programs for deleting and tagging master and trailer records
- Unload program for reorganizing master and trailer files.

Control-Sequential Programs

These programs are:

- Load program
- Additions program
- Programs for deleting and tagging records
- Reorganization program

File Organization Programs (IBM 1405)

A set of six programs that implement the chaining method of disk file organization is available. These programs aid users in establishing and maintaining their data files in IBM 1405 Disk Storage.

Chain Load of Master Records

This program loads records into disk storage from either punched cards or magnetic tape.

Chain Additions of Master Records

This program loads additional records from either cards or tape into a previously established disk file.

Chain Deletions of Master Records

This program enables the user either to flag a record as a deletion or actually to remove the record from the file and relink chains where necessary.

Trailer Load Program

This program allows trailer records from either cards or tape to be loaded into an area of a disk file not being used for master records.

Disk-to-Tape Utility Program for File Organization

This program allows a chained file to be unloaded onto magnetic tape so that it can be reorganized.

Disk-to-Card Utility Program for File Organization

This program allows a chained file to be unloaded into punched cards so that it can be reorganized.

Data Communications Utility Programs for IBM 1009

The Data Communications Utility programs are a group of seven distinct IBM programs. Their purpose is to control the transfer of data over common-carrier lines between any two of the following systems: IBM 1401 with 1009, IBM 1460 with 1009, and IBM 1440 with 1009. Three of the seven programs are for use in the transmitting system; that is, the system that is sending the data. The four remaining programs are for use in the receiving system; that is, the system to which the transmitting system is sending data.

Each of the three *transmit programs* controls the sending of data to the receiving system from a particular input unit in the transmitting system.

Each of the four *receive programs* controls a particular output operation on the data sent by the transmitting system to the receiving system.

In addition to controlling the transfer of data between the systems previously mentioned, the Data Communications Utility programs can also control data transmission to, or receive data transmitted from, the following:

1. an IBM 1410 with 1009.
2. an IBM 7701 or 7702 Tape Transmission Terminal.
3. an IBM 1013 Card Transmission Terminal.
4. an IBM 7710 Transmission Control Unit.
5. an IBM 1009 Data Transmission Unit.

IBM 1401-1009 Utility Program

This utility program makes a 1401-1009 system operational with a minimum of 1401 programming effort. The program can be used at any installation that has an IBM 1401 Data Processing System communicating (by means of an IBM 1009 Data Transmission Unit and communications-company line facilities) with another 1401-1009 installation, an IBM 1410-1009 installation, or an IBM 7701 Magnetic Tape Transmission Terminal. The program performs card-to-card, card-to-tape, tape-to-card, and tape-to-tape transmission as desired by the user.

IBM 1401-7710 Tape-Transmit Utility Program

This program controls the transmission of tape data records from a 1401 system equipped with an IBM 7710 Data Communication Unit to a remote terminal. The remote terminal can be an:

- IBM 1401-7710
- IBM 1401-1009
- IBM 7701
- IBM 7702
- IBM 1013

Included in the program are functions of monitoring the responses from the remote terminal and retransmitting a record if necessary. If a read tape error occurs, the tape-error routine permits up to 99 attempts to read the error record.

This program is self-loading. The user prepares a control card that provides certain information to the program. The program uses this information to modify itself according to the requirements of the user's application.

IBM 1401-7710 Tape-Receive Utility Program

This program controls the reception and the storage (on magnetic tape) of data records from a remote terminal to a 1401 system equipped with an IBM 7710 Data Communications Unit. The remote terminal can be one of the systems or units listed under IBM *1401-7710 Tape-Transmit Utility Program*.

If an error record is received, it is not processed. Instead, the 7710 signals the remote terminal to retransmit the record. If a tape write error occurs, ten attempts are made to write the record.

Like the tape-transmit program, this program is self-loading. It also uses a control card that modifies the program according to the user's requirements.

IBM 1401-7710 Transmit-Receive Utility Program

This program controls the operation of a 1401 system equipped with an attached IBM 7710 Data Communication Unit to perform these functions:

- Transmit data records to a remote terminal.
- Receive data records from a remote terminal.
- Read or write on magnetic tape.
- Through program exits, gather or store data records from sources other than magnetic tape units.
- Through program exits, integrate the program with the user's operating programs.

The remote terminal can be one of the systems or units listed under IBM *1401-7710 Tape-Transmit Utility Program*.

The program incorporates a priority loop that controls the sequence of operations. Because the transmit-receive program continually tests for certain conditions over which the user has sense-switch control, the user can direct the program to perform the foregoing functions.

This self-loading program uses a control card that the user prepares. The card modifies the program according to the user's requirements.

IBM 7750 Assembly Program Using the IBM 1401

This assembly program produces object programs for the IBM 7750 Programmed Transmission Control. It can also produce a program listing. The assembly program uses symbolic source programs in punched-card form as input to the 1401. The user writes the source program in the symbolic language of the IBM 7750, using a program sheet designed for this assembly program. He selects the output medium for the object program (punched-card, magnetic-tape, or both). Object programs are assembled in the machine language of the IBM 7750.

IBM 1401 Peripheral Integrated Programming System for Use with 7000-Series Data Processing Systems

This system of 1401 programs controls a 1401 that is used as an auxiliary, off-line, editing and output device for an IBM 7000-series data processing system. The 1401 Peripheral Integrated Programming System (PIPS) consists of a set of rules and a system tape. It accepts, as its input data file, the I-language (interpretative lan-

gauge) output, in card or magnetic-tape form, that was produced on a 7000-series data processing system. (The I-language output from the 7000-series system contains not only the data to be processed, but the controls for processing the data, as well.) PIPS produces output in printed form, punched-card form, or both, according to the user's option. Thus, 1401 PIPS permits consecutive execution of peripheral programs that are independent of each other, both in their operations and in the data they process.

The PIPS system tape contains these 1401 programs: a peripheral monitor, two D-programs (decoding programs), and a librarian. The peripheral monitor program, by reading a card or a tape flag record, selects the appropriate D-program and relinquishes control to it. Provisions are made for checkpoints, restart options, and label options. The D-programs accept and

decode I-language data and process it. Two D-programs are supplied by IBM as part of the PIPS system tape. One of these produces printed output. The other produces printed output, punched output, or both. The librarian program can modify the PIPS system tape, by adding and deleting sections from it.

IBM 1401 Input/Output Control Program for Use with the IBM 7040-7044

An IBM 1401 system can serve as the means of on-line input or output for the IBM 7040 or 7044. The program, 1401 Input/Output Control Program for use with the IBM 7040-7044, controls the operation of a 1401 used on-line through data-channel A with a 7040 or a 7044. Included are routines to control card reading and punching, as well as printing. Exits are provided to permit magnetic-tape routines to be incorporated.

Index

A-Address	15, 25, 28, 29	Data Flow (Tape System)	22
Access Assembly	27, 28	d-Character	16, 25, 28, 29
Actual Machine Language	42	Decimal Control	31
Additional Access Arm (1405 Feature)	33	Direct Data Channel (1401 Feature)	32
Address, A-	15, 25, 28, 29	Direct Seek (1311 Feature)	28, 33
Address, B-	16, 25, 28, 29	Disk Instructions (IBM 1311)	28
Address, I-	16	Disk Instructions (IBM 1405)	29
Address Registers	17	Disk Label Program (1311 Utility Program)	52
Address Validity Checking	15	Disk-Oriented System	6
Addressing	16	Disk Packs	26
Addressing, Disk (IBM 1311)	28	Disk-Record-Load (1311 Utility Program)	52
Addressing, Disk (IBM 1405)	28	Disk Storage	8, 26, 28
Addressing (IBM 1406)	21	Disk Storage (IBM 1311)	26
Advanced Programming Features	30	Disk Storage (IBM 1405)	28, 33
Arithmetic Function	9	Disk-Storage Addressing (IBM 1311)	28
Arithmetic Operation Codes	18	Disk-Storage Addressing (IBM 1405)	28
Assembly for Other Systems	10	Disk-Storage-Oriented System	26
Asterisk Protection	31	Disk-to-Card (1311 Utility Program)	52
Autocoder (on Disk)	45	Disk-to-Card (1405 Utility Program)	52
Autocoder (on Tape)	45	Disk-to-Card Utility Program (1405 File Organization)	53
Autotest	49	Disk-to-Printer (1405 Utility Program)	53
Autotest (8K and 16K)	49	Disk-to-Tape (1311 Utility Program)	52
Auxiliary Ribbon Feeding (1403 Feature)	33	Disk-to-Tape (1405 Utility Program)	52
B-Address	16, 25, 28, 29	Disk-To-Tape Utility Program (1405 File Organization)	53
Basic Autocoder 2K	42	Disk Utility Programs (IBM 1311)	52
Basic 4K Report Program Generator	47	Disk Utility Programs (IBM 1405)	52
Binary Coded Decimal	8	Early Card Read (1402 Feature)	32
Bit Test (1401 Feature)	30	Editing	9, 18
Card-Oriented System	6, 11	800 Characters per Inch (1401 Feature)	32
Card Program Error-Detection Aids	51	Expanded Print Edit (1401 Feature)	31
Card Subroutines	50	<i>Fargo</i> (Fourteen-O-One Generating Operation)	48
Card System Programs	50	Features, Special	30
Card-to-Disk (1311 Utility Program)	52	51-Column Cards	32
Card-to-Disk (1405 Utility Program)	53	File Feed	12
Card-to-Tape (Tape Utility Program)	51	File Organization Programs (IBM 1311)	53
Card Utility Programs	50	File Organization Programs (IBM 1405)	53
Cards, 51-Column	32	Floating Dollar Sign	31
Chain Additions of Master Records (1405 File Organization)	53	Fortran	45
Chain Deletions of Master Records (1405 File Organization)	53	Fortran IV	46
Chain Load of Master Records (1405 File Organization)	53	High-Low-Equal Compare (1401 Feature)	30
Chaining	17	Hole Count	15
Checking	9, 15	I-Address	16
Checking, Hole Count	15	IBM 729 Magnetic Tape	22, 23
Checking, Parity	15	IBM 1009 Data Transmission Unit	35
Checking, Tape	24	IBM 1011 Paper Tape Reader	37
Checking, Validity	15	IBM 1012 Tape Punch	37
Circuitry, Solid-State	9	IBM 1012 Tape Punch Routines	51
Clear Disk Storage (1311 Utility Program)	52	IBM 1026 Transmission Control Unit	36
Clear Disk Storage (1405 Utility Program)	52	IBM 1231 Optical Mark Page Reader	37
Cobol (on Disk)	46	IBM 1285 Optical Reader	38
Cobol (on Tape)	46	IBM 1311 Disk Storage	26
Column Binary (1401 Feature)	31	IBM 1311 Disk Storage Drive	26, 27, 33
Common Stacker (8/2 Stacker)	13	IBM 1316 Disk Packs	26
Communications IOCS (1026-DDC)	47	IBM 1401-1009 Utility Program	54
Communications IOCS (1448-7740-DDC)	47	IBM 1401-7710 Tape-Receive Utility Program	54
Compressed Tape (1401 Feature)	32	IBM 1401-7710 Tape-Transmit Utility Program	54
Control-Sequential Programs (1311 File Organization)	53	IBM 1401-7710 Transmit-Receive Utility Program	54
Copy Disk (1311 Utility Program)	52	IBM 1401 Console	19
Core Storage	7	IBM 1401 Input/Output Control Program for	
Cylinder	27	Use with the IBM 7040-7044	55
Data Communications Utility Programs for IBM 1009	53	IBM 1401 Peripheral Integrated Programming System for	
Data Flow (Card System)	14	Use with 7000-Series Data Processing Systems	54
Data Flow (Disk System)	26		

IBM 1401 Processing Unit	11, 30	Print Disk (1311 Utility Program)	52
IBM 1401 Programs and Programming Systems	42	Processing	8
IBM 1401 Used with Other Systems	9	Processing Overlap (1401 Feature)	30
IBM 1402 Card Read-Punch	11, 12, 32	Processing Unit	8, 11, 30
IBM 1403 Printer	11, 13, 33	Program, Stored	6
IBM 1404 Printer	33, 39	Program, Symbolic	42
IBM 1405 Disk Storage	28, 33	Programs and Programming Systems	42
IBM 1406 Storage Unit	20	Print Storage (1401 Feature)	31
IBM 1407 Console Inquiry Station	29	Punch-Feed Read (1402 Feature)	32
IBM 1412 and 1419 Magnetic Character Readers	38	Random Programs (1311 File Organization)	53
IBM 1418 Optical Character Reader	38	Read Check Station	12, 13
IBM 1428 Alphameric Optical Reader	39	Read-Compare (1404 Feature)	33
IBM 1445 Printer	40	Read Punch Release (1401 Feature)	31
IBM 7330 Magnetic Tape	23, 24	Registers, Address	17
IBM 7340 Hypertape Drive Model 2	40	Report Program Generator (RPG)	48
IBM 7710 Data Communication Unit	35	Report Program Generator for IBM 1401-1311	48
IBM 7740 Communication Control System	36	Scan Disk (1311 Feature)	33
IBM 7750 Assembly Program Using the IBM 1401	54	Scientific Data Processing Systems	10
IBM 7770 Audio Response Unit	36	Sector Address	28
IBM Scientific Data Processing Systems	10	Seek Overlap Feature	34
Indexing (1401 Advanced Programming Feature)	30	Selective Tape Listing (1403 Feature)	33
Input/Output Codes	18	Sense Switches (1401 Feature)	31
Input/Output Control System (on IBM 1311)	46	Serial Input/Output Adapter (1401 Feature)	32
Input/Output Control System (on Tape)	46	Sign Control Left	31
Input/Output Storage Assignments	16	Solid-State Circuitry	9
Instruction (Example)	16	Sort 1	48
Instruction Format	15	Sort 3	48
Instruction, Disk (IBM 1311)	28	Sort 4	48
Instructions, Disk (IBM 1405)	29	Sort 6	48
Instructions, Stored-Program	15	Sort 7 and Merge 7	49
Instructions, Tape	25	Sorts 61, 62, 63, and 64	49
Interchangeable Chain Cartridge Adapter (1403 and 1404 Feature)	33	Space Suppression (1401 Feature)	31
Interchangeable 51-Column Read Feed (1402 Feature)	32	Special Features	30
Interleaving	14	SPS (Symbolic Programming System)	42
Language	8	Storage Assignments, Input/Output	16
Library	8, 45, 46	Storage, Magnetic-Core	7
Load Codes	18	Storage, Magnetic-Disk	8, 26, 28
Loading	18	Storage, Magnetic-Tape	7, 22
Logic Function	8	Store Address Register (1401 Advanced Programming Feature)	30
Logic Operation Codes	18	Stored Program	6
Magnetic-Core Storage	7	Stored-Program Instructions	15
Magnetic-Disk Storage	8, 26, 28	Symbolic Programs	42
Magnetic-Tape-Oriented System	22	System, Card-Oriented	11
Magnetic-Tape Storage	7, 22	System Concepts	6
Merge 6	49	System Design	9
Merge 7	49	System, Disk-Oriented	26
Minimum Machine Requirements (for Programs)	42	System, Tape-Oriented	22
Miscellaneous Operation Codes	18	2K Report Program Generator	47
Move Codes	18	Tape Checking	24
Move Record (1401 Advanced Programming Feature)	30	Tape Instructions	25
Multiple Utility Program (Tape Utility Program)	51	Tape Intermix (1401 Feature)	32
Multiple(Tape) Utility Program with 120-Character Label Capability	51	Tape-Oriented System	22
Multiply-Divide (1401 Feature)	30	Tape Reading and Writing Subroutines	51
Normal Punch Stacker	13	Tape Storage	7, 22
Normal Read Stacker	12	Tape System Utility Programs	51
Numerical Print (1403 Feature)	33	Tape-to-Card (Tape Utility Program)	51
Operation, Off-Line	10	Tape-to-Disk (1311 Utility Program)	52
Operation, On-Line	9	Tape-to-Disk (1405 Utility Program)	53
Operation Code	15, 18	Trailer Load Program (1405 File Organization)	53
Operation Codes, Arithmetic	18	Tape-to-Printer (Tape Utility Program)	51
Operation Codes, Input/Output	18	Track Record (1311 Feature)	34
Operation Codes, Logic	18	Validity (Address)	15
Operation Codes, Miscellaneous	18	Word Mark	15, 16
Operation Codes, Move and Load	18	Words	12, 16
Other Input/Output Units for IBM 1401	35	Write and Punch (Interleaving)	14
Parity	15	Write and Read (Interleaving)	14
Physical Features (Card System)	11	Write, Read, and Punch (Interleaving)	14



International Business Machines Corporation

Data Processing Division

112 East Post Road, White Plains, N. Y. 10601